

**TOSHIBA**

**MULTIFUNCTIONAL DIGITAL SYSTEMS**

# **User's Guide**

---

**e-STUDIO2329A/2829A**



# Preface

---

Thank you for purchasing the Toshiba multifunctional digital systems. This manual describes how to use, perform maintenance, and fix problems for this equipment. Be sure to read this manual before using this equipment. Keep this manual handy and retain it for future reference.

## ■ How to read this manual

### □ Symbols in this manual

In this manual, some important items are described with the symbols shown below. Be sure to read these items before using this equipment.

**⚠ WARNING** Indicates a potentially hazardous situation which, if not avoided, could result in death, serious injury, or serious damage, or fire in the equipment or surrounding objects.

**⚠ CAUTION** Indicates a potentially hazardous situation which, if not avoided, may result in minor or moderate injury, partial damage to the equipment or surrounding objects, or loss of data.

**Note** Indicates information to which you should pay attention when operating the equipment.

**Tip** Describes handy information that is useful to know when operating the equipment.

 Pages describing items related to what you are currently doing. See these pages as required.

### □ Description of original/paper direction

Paper or originals of A4 or B5/LT size can be placed either in a portrait direction or in a landscape direction. In this manual, “-R” is added to this paper size when this size of paper or original is placed in a landscape direction.

e.g.) A4/LT size original on the original glass

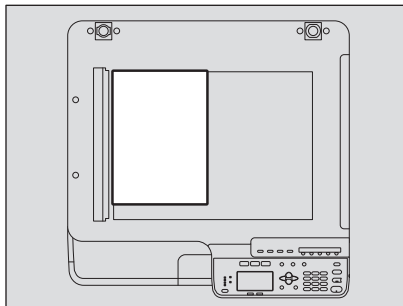

Placed in a portrait direction: A4/LT

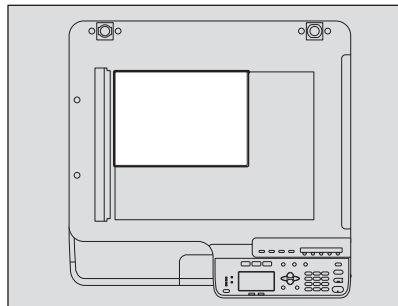

Placed in a landscape direction: A4-R/LT-R

Paper or originals of A3 or B4/LD or LG size can only be placed in a landscape direction, therefore “-R” is not added to these sizes.

### □ Screens

- In this manual, the screens and the operation procedures in Windows are described for Windows 10. Screenshots and explanations for Mac OS are based on macOS10.14. The details on the screens may differ depending on how the equipment is used, such as the status of the installed options, the OS version and the applications.
- The illustration screens used in this manual are for paper in the A/B format. If you use paper in the LT format, the display or the order of buttons in the illustrations may differ from that of your equipment.

### □ Trademarks

For trademarks, refer to the **Safety Information**.

---

## ■ Lineup of our manuals

These manuals are provided for the operation of the e-STUDIO2329A/2829A. Select and read the manual best suited to your needs. This manual is the **User's Guide**.

### **Safety Information (Printouts)**

This manual describes the necessary precautions for use. For your added security, be sure to read this manual first.

### **Quick Guide (Printouts)**

This manual describes the components, preparations, basic operations, and troubleshooting for the equipment.

### **User's Guide (PDF file, this manual)**

This manual describes preparations for using the e-STUDIO2329A/2829A, and how to use functions such as copying, printing, and scanning. It also describes maintenance and troubleshooting for the problems that could occur while you are using the equipment.

### **Software Installation Guide (PDF file)**

This manual describes how to install and uninstall printer and scanner drivers.

### **TopAccess Guide (PDF file)**

This manual describes how to use the co-packed utility "TopAccess". The settings and management of the equipment can be done using a Web browser.

### **Fax Guide (PDF file)**

This manual describes how to use the Fax functions. Various functions both basic and advanced regarding Fax transmission/reception are available.

### **Help menu for client software**

To run the following client software, refer to the Help menu of each:

- Printer driver
- Scan driver
- N/W-Fax driver
- e-STUDIO Scan Editor

## □ To read manuals in the PDF file format

This manual in the PDF (Portable Document Format) can be displayed/printed using Adobe Acrobat Reader. If it is not installed in your computer, download it via the website of Adobe Systems.

## ■ Recommended toner cartridges

For optimal printing performance, we recommend that you use genuine Toshiba toner cartridges. If you use a Toshiba-recommended toner cartridge, the following functions are available.

**Cartridge detecting function:** This function checks if the toner cartridge is correctly installed and notifies you if it is not.

**Toner remaining check function:** This function notifies you when there is little toner remaining in the cartridge, as well as notifying your authorized service representative automatically by remote service.

**Image quality optimization function:** This function controls image quality according to the characteristics of the toner to be used and enables you to print images of an optimal quality.

Toshiba cartridges and containers are engineered to specifications designed to provide the best possible performance and image quality. Toshiba recommends that genuine Toshiba products are used to maintain peak performance and functionality.

If you are using a toner cartridge other than the one we recommend, the toner may not be recognized. If this occurs, contact your service representative. Toshiba Imaging Equipment does not prevent the use of Non-Manufacturer Cartridges and Containers.

# CONTENTS

---

<b>Preface</b> .....	<b>3</b>
----------------------	----------

## **Chapter 1 PREPARATION**

---

<b>Components</b> .....	<b>10</b>
Front/Left side/Inner side.....	10
Right side.....	12
Configuration of options .....	13
Control panel .....	14
Main screen (Copy) .....	17
<b>Preparation 1 - Turning Power ON</b> .....	<b>18</b>
Turning on.....	18
Saving energy when not in use - Energy saving mode - .....	19
<b>Preparation 2 - Loading Paper</b> .....	<b>20</b>
Acceptable paper types .....	20
Recommended paper .....	21
Loading paper in the drawer/Paper Feed Unit.....	23
Loading paper in the drawers of Paper Feed Pedestal .....	25
Loading paper on the bypass tray.....	27
Loading an envelope on the bypass tray .....	29
<b>Preparation 3 - Registering Paper Size and Type</b> .....	<b>32</b>

## **Chapter 2 COPY FUNCTIONS**

---

<b>Basic Copy Procedure</b> .....	<b>34</b>
Acceptable originals .....	34
Copying originals .....	35
<b>Copy Settings</b> .....	<b>40</b>
Adjusting the exposure .....	40
Selecting the original mode .....	41
Selecting the paper.....	42
Enlarging or reducing the copy size .....	44
Sorting pages .....	49
Copying two or four pages on each sheet .....	51
Copying both sides of a card on a sheet .....	53
Erasing the shadow on edges.....	55
Copying right and left pages separately .....	56
Shifting the pages to the right or left .....	57
Copying on one or both sides.....	58
Adding a page number and date/time on the copied paper .....	61
Removing blank pages .....	61
Copying different sizes in one go .....	62
Image direction .....	63
Continuing the scanning for a copy .....	64
<b>Using Templates (Copy)</b> .....	<b>65</b>
Registering the templates .....	65
Recalling a template .....	66

## **Chapter 3 PRINT FUNCTIONS (Windows)**

---

<b>Before Using the Printer Driver</b> .....	<b>68</b>
Configuring the options.....	68
Setting the department code .....	71
<b>Printing From Application</b> .....	<b>73</b>

---

Considerations and limitations.....	73
How to print .....	73
<b>Status Monitor .....</b>	<b>75</b>
Monitoring the print status and reporting print errors.....	75
<b>Setting up Print Options .....</b>	<b>76</b>
How to set up .....	76
Print options.....	79
<b>Printing With Best Functions for Your Needs .....</b>	<b>95</b>
Layout and finishing options in [Basic] tab menu.....	95
Layout and finishing options in [Finishing] tab menu .....	96
Finishing options in [Effect] tab menu.....	99

## **Chapter 4 PRINT FUNCTIONS (macOS)**

---

<b>Printing from Application .....</b>	<b>104</b>
Considerations and limitations.....	104
How to print .....	104
<b>Setting up Print Options .....</b>	<b>106</b>
[Page Setup] options .....	106
[Print] options.....	108

## **Chapter 5 SCAN FUNCTIONS**

---

<b>Scanning From Application .....</b>	<b>118</b>
How to scan.....	118
<b>Setting up Scan Options.....</b>	<b>120</b>
Scan options.....	120
Scanning from the equipment on the network.....	123
Scanning from the equipment connected by USB cable.....	123
Using the Easy Set feature.....	124
<b>Scanning from e-STUDIO Scan Editor .....</b>	<b>125</b>
Features of e-STUDIO Scan Editor .....	125
Application window .....	125
File window for the scanned images .....	130
Setting the preferences .....	133
<b>Scan to E-Mail .....</b>	<b>137</b>
Procedure for Scan to E-Mail.....	137
<b>Scan to File .....</b>	<b>140</b>
Procedure for Scan to File .....	140
<b>Scan to USB Memory.....</b>	<b>143</b>
Procedure for Scan to USB Memory.....	143
<b>Scan to Mobile .....</b>	<b>146</b>
Procedure for Scan to Mobile.....	146
<b>Scan Settings.....</b>	<b>149</b>
Selecting the color mode.....	149
Selecting the resolution .....	149
Scanning the 2-sided originals.....	150
Selecting the original size.....	150
Scanning different sizes in one go .....	151
Selecting the original mode .....	151
Selecting the orientation.....	152
Selecting the compression ratio .....	152

---

Removing blank pages .....	153
Adjusting the exposure .....	153
Continuing the scanning .....	154
Specifying E-mail Addresses .....	154
Character entry .....	158
Scan speed .....	159
<b>Using Templates (Scan) .....</b>	<b>161</b>
Registering the templates .....	161
Recalling a template .....	162

## **Chapter 6 VARIOUS FUNCTIONS**

---

<b>Copy Menu List.....</b>	<b>164</b>
Copy menu items .....	164
<b>Scan Menu List .....</b>	<b>165</b>
Scan menu items .....	165
<b>Network Menu List .....</b>	<b>168</b>
NIC status .....	168
Setting the Ethernet speed.....	168
Setting the TCP/IP protocol.....	169
Setting the HTTP network service.....	170
<b>User Functions Menu List .....</b>	<b>171</b>
User functions menu items .....	172
<b>Department Management .....</b>	<b>183</b>
<b>Job Status .....</b>	<b>185</b>
JOB STATUS menu items.....	185

## **Chapter 7 TROUBLESHOOTING**

---

<b>When This Message Appears .....</b>	<b>190</b>
<b>Paper Misfeed .....</b>	<b>193</b>
Find the position of paper misfeeds .....	193
When paper misfeeds occur frequently .....	193
When removing misfed paper .....	193
Paper misfeeds on the Reversing Automatic Document Feeder (RADF).....	194
Paper misfeeds on the bypass tray .....	196
Paper misfeeds inside of the side cover .....	196
Paper misfeeds within the Paper Feed Unit .....	198
Paper misfeeds within the Paper Feed Pedestal.....	199
<b>Replacing Toner Cartridge .....</b>	<b>201</b>
When a message for replacement appears .....	201
<b>Before Calling Service Technician .....</b>	<b>204</b>
General operation .....	204
Toner-related items .....	204
Original/Paper-related items .....	205
Image trouble.....	205

## **Chapter 8 MAINTENANCE AND INSPECTION**

---

<b>Regular Cleaning .....</b>	<b>208</b>
<b>Cleaning Charger.....</b>	<b>209</b>

---

**Chapter 9 APPENDIX**

---

<b>e-STUDIO2329A/2829A Specifications .....</b>	<b>212</b>
Continuous copying speed .....	213
<b>Specifications of Options .....</b>	<b>214</b>
<b>Packing List .....</b>	<b>216</b>
<b>Copying Function Combination Matrix .....</b>	<b>217</b>
Combination matrix.....	217
<b>INDEX .....</b>	<b>219</b>



# 1

## PREPARATION

<b>Components .....</b>	<b>10</b>
Front/Left side/Inner side.....	10
Right side.....	12
Configuration of options .....	13
Control panel .....	14
Main screen (Copy) .....	17
<b>Preparation 1 - Turning Power ON .....</b>	<b>18</b>
Turning on.....	18
Saving energy when not in use - Energy saving mode - .....	19
<b>Preparation 2 - Loading Paper .....</b>	<b>20</b>
Acceptable paper types .....	20
Recommended paper .....	21
Loading paper in the drawer/Paper Feed Unit.....	23
Loading paper in the drawers of Paper Feed Pedestal .....	25
Loading paper on the bypass tray.....	27
Loading an envelope on the bypass tray .....	29
<b>Preparation 3 - Registering Paper Size and Type .....</b>	<b>32</b>

## Components

### ■ Front/Left side/Inner side

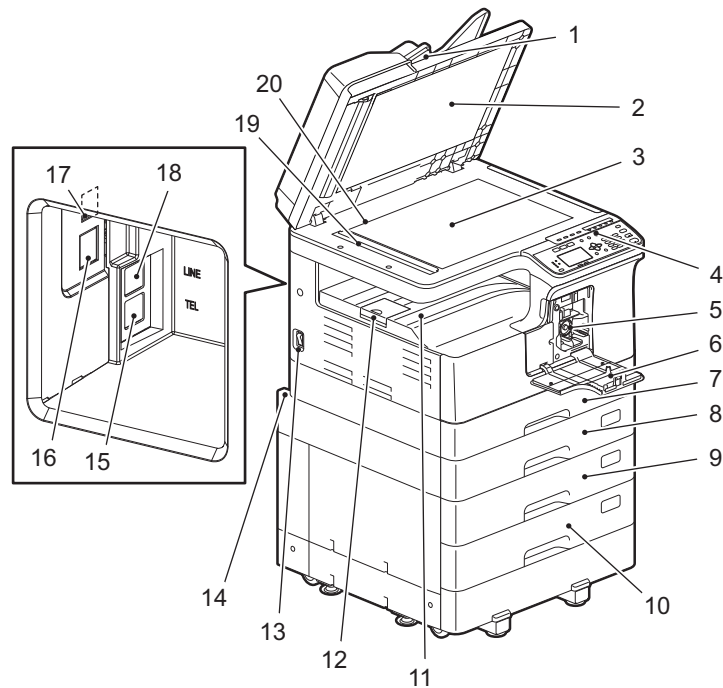

**1. Reversing Automatic Document Feeder (RADF) (optional)**

The stack of originals is scanned one sheet at a time. Both sides of the originals can be scanned. A maximum of 50 sheets (80 g/m<sup>2</sup> or 20 lb. Bond) can be placed in one go. (The maximum number of sheets that can be set may vary depending on the media type of the originals.)

📖 P.193 “Paper Misfeed”

**2. Platen sheet**

📖 P.208 “Regular Cleaning”

**3. Original glass**

Place the book-type originals and special paper such as overhead transparencies or tracing paper, as well as plain paper.

**4. Control panel**

Make settings to use the various functions on this equipment.

📖 P.14 “Control panel”

**5. Toner cartridge**

For the recommended toner cartridges, refer to the **Safety Information**.

📖 P.201 “Replacing Toner Cartridge”

**6. Front cover**

Open this when you replace the toner cartridge.

📖 P.201 “Replacing Toner Cartridge”

**7. Drawer**

Place up to 250 sheets of plain paper (80 g/m<sup>2</sup> or 20 lb. Bond).

📖 P.23 “Loading paper in the drawer/Paper Feed Unit”

**8. Paper Feed Unit (optional)**

Use the Paper Feed Unit to add the second drawer. A maximum of 250 sheets (80 g/m<sup>2</sup> or 20 lb. Bond) of plain paper can be placed in one go.

**9. Paper Feed Pedestal (optional)**

Use the Paper Feed Pedestal to add one drawer. The Drawer Module can be installed in this device. A maximum of 550 sheets (80 g/m<sup>2</sup> or 20 lb. Bond) can be placed in one go.

**10. Drawer Module (optional)**

Use this to add one more drawer to the Paper Feed Pedestal (optional). A maximum of 550 sheets (80 g/m<sup>2</sup> or 20 lb. Bond) can be placed in one go.

**11. Receiving tray****12. Paper exit stopper**

Stops large paper from sliding out of the receiving tray.

**13. Power switch**

Turns the power ON or OFF.

 P.18 "Preparation 1 - Turning Power ON"

**14. AC-IN terminal (rear)**

Connect the power cable supplied with the equipment.

**15. TEL (optional)**

Connect to an external telephone.

For details on how to use the Fax functions, see the following manual.

 **Fax Guide**

**16. Network interface connector**

Use this connector when connecting this equipment to a network.

**17. USB terminal (4-pin)**

Connect to your PC using a commercially available USB cable.

**Note**

- Use a USB2.0 Hi-Speed certified cable: USB cable supporting the USB2.0 Hi-Speed mode (480 Mbps of transfer speed) certified by the USB Implementers Forum.
- Connect the equipment with a PC directly by the USB cable. When it is connected with a PC via a USB hub, the equipment may not be recognized.

**18. LINE (optional)**

Connect to the public switched telephone network.

For details on how to use the Fax functions, see the following manual.

 **Fax Guide**

**19. Scanning area**

The data of originals transported from Reversing Automatic Document Feeder are scanned here.

 P.208 "Regular Cleaning"

**20. Original scale**

Confirm the size of an original placed on the original glass.

---

## ■ Right side

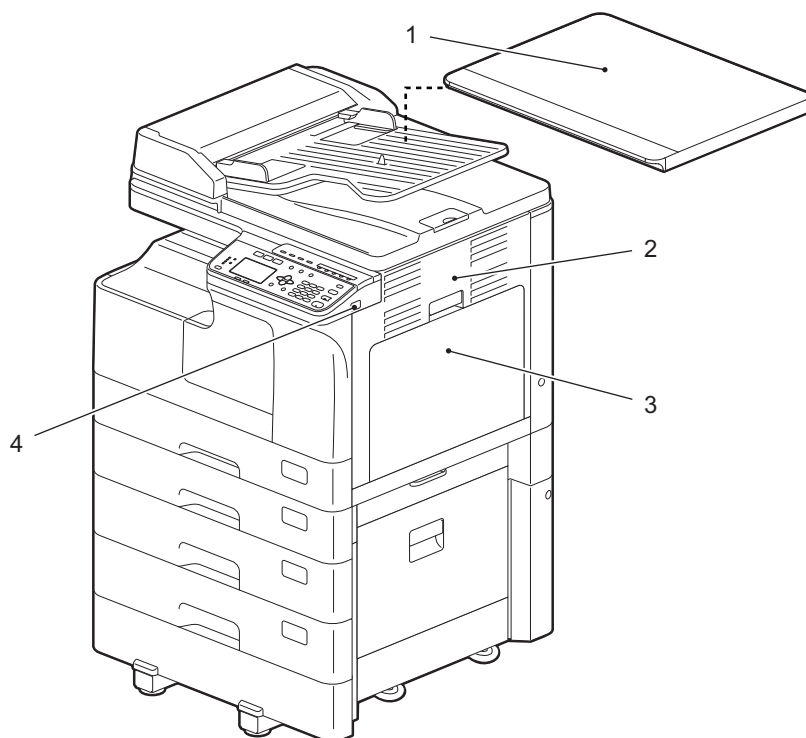

**1. Platen Cover (optional)**

Close this before start copying or scanning.

**2. Side cover**

**3. Bypass tray**

Place special paper such as thick paper, overhead transparencies, or tracing paper.

 P.27 "Loading paper on the bypass tray"

 P.29 "Loading an envelope on the bypass tray"

**4. USB port**

Connect a USB device to store scanned data or print files stored in the USB device.

## ■ Configuration of options

The available options are listed below. Contact your service technician or service representative for details.

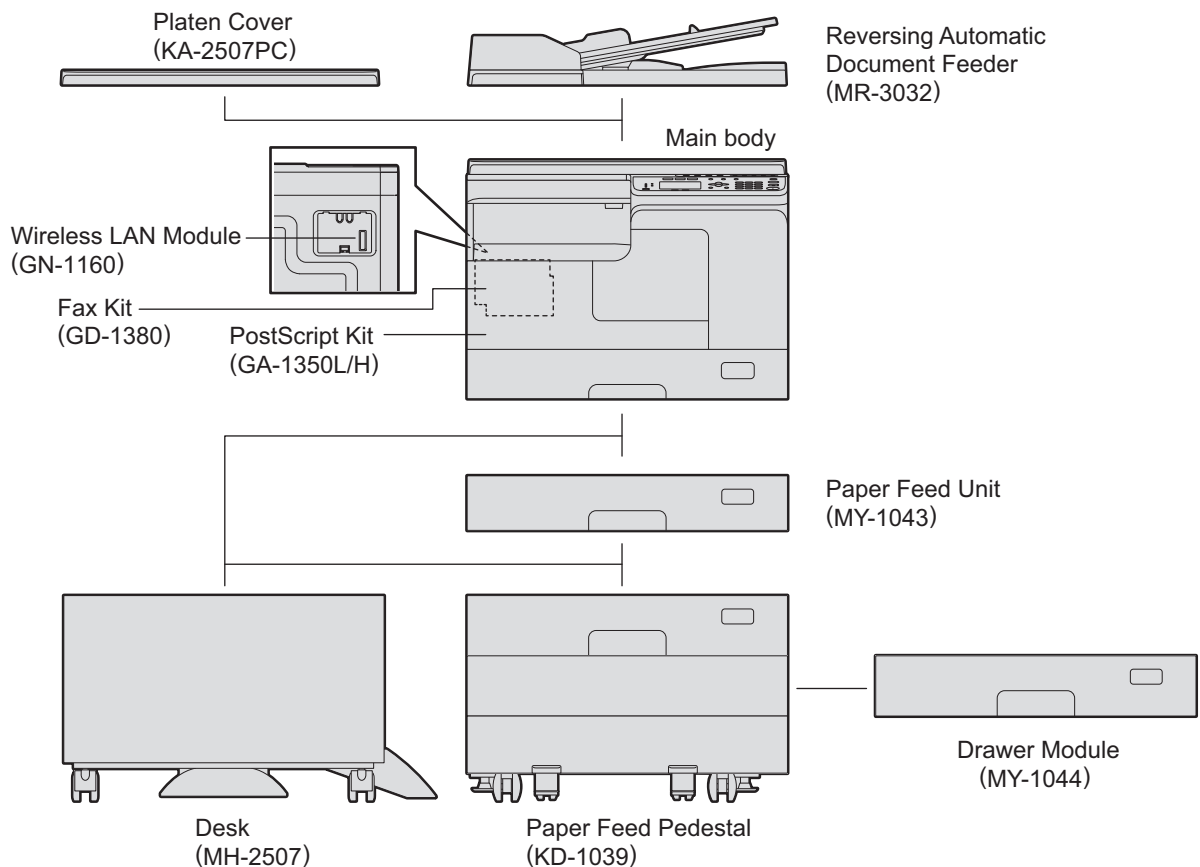

## Control panel

The functions and indications of the ▷ button vary depending on the region. The illustrations show the control panel for Europe and the Americas unless they are specified.

### For Europe and the Americas

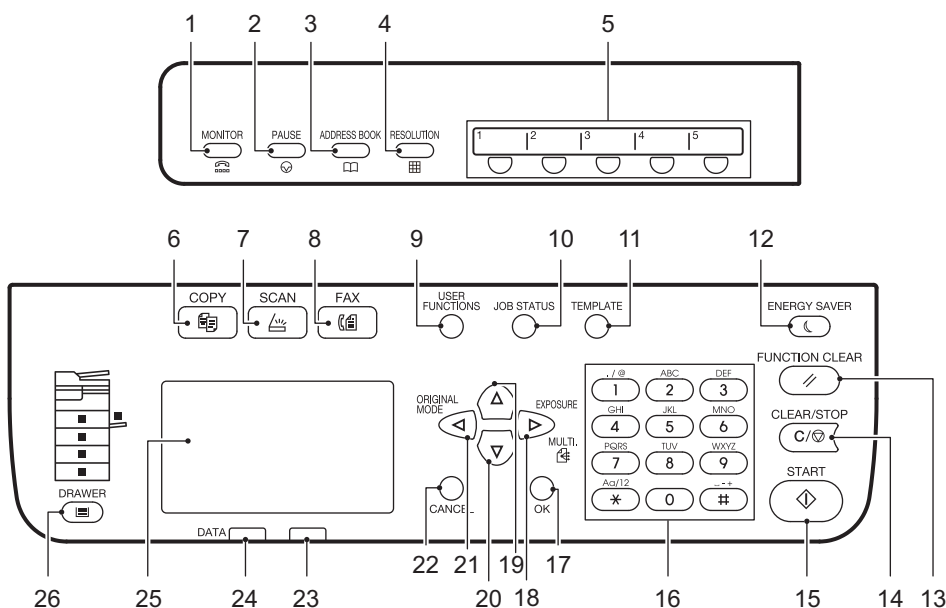

### For regions other than Europe and the Americas

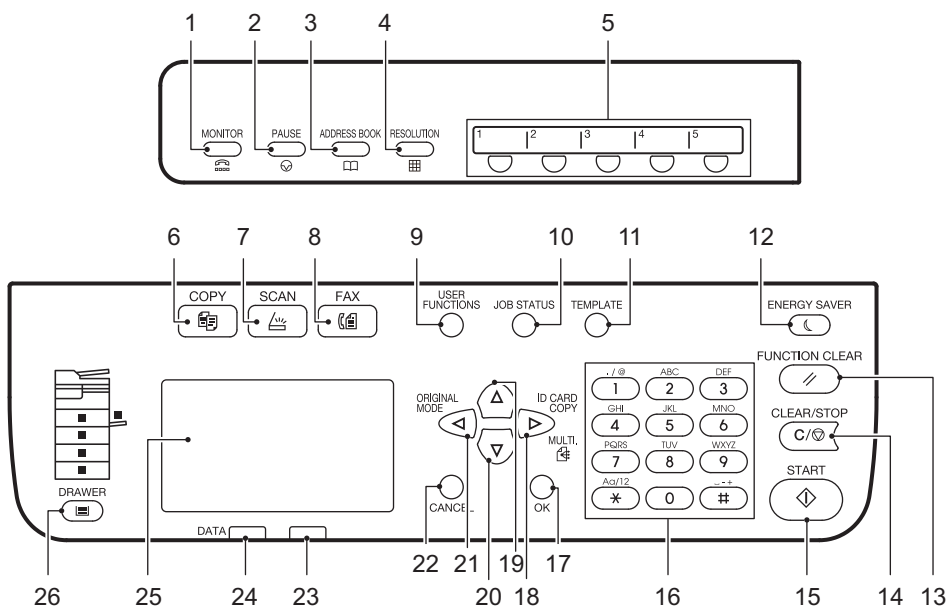

#### 1. [MONITOR] button

Use this button to dial the number without picking up the handset of the external telephone.

#### 2. [PAUSE] button







Use this button to inset a pause (of approximately 2 seconds) while dialing a fax number. Available only when the Fax Unit (optional) is installed.

#### 3. [ADDRESS BOOK] button

Use this to display the Address book. Available only when the Fax Unit (optional) is installed.

#### 4. [RESOLUTION] button

Use this to select the resolution for sending a fax. Available only when the Fax Unit (optional) is installed.

5. **One Touch button**  
Speed button for sending a fax. Available only when the Fax Unit (optional) is installed.
6. **[COPY] button**  
Press this button to use the copy functions.
7. **[SCAN] button**  
Press this button to use the scan functions.
8. **[FAX] button**  
Press this button to use the Fax functions. Available only when the Fax Unit (optional) is installed.  
For details on how to use the Fax functions, see the following manual.  
 **Fax Guide**
9. **[USER FUNCTIONS] button**  
Changes the equipment's default settings.  
 P.171 "User Functions Menu List"
10. **[JOB STATUS] button**  
Displays the processing status of print, scan, or fax, as well as allowing you to view the performance history and delete the job.  
 P.185 "Job Status"  
For details on how to use the Fax functions, see the following manual.  
 **Fax Guide**
11. **[TEMPLATE] button**  
Creates and recalls template settings.  
 P.65 "Using Templates (Copy)"  
 P.161 "Using Templates (Scan)"
12. **[ENERGY SAVER] button**  
Enters into the energy saving mode.
13. **[FUNCTION CLEAR] button**  
Restores all the selected functions to the defaults.
14. **[CLEAR/STOP] button**  
Clears the number entered with the digital keys such as the number of copies, as well as cancels scanning or copying the original.
15. **[START] button**  
Starts the copying, scanning or faxing operation.
16. **Digital keys**  
Enters numbers such as the number of copies, password or fax number.

---

**17. [OK] button**

Determines the items or operations selected in each menu.

**18. ▷ button**

- Press this button on the menu screen to move to one lower layer of the item or to increase the setting value.
- Press this button once on the main screen (Copy) to show the “EXPOSURE” screen for Europe and the Americas, or the “ID CARD” screen for regions other than Europe and the Americas.  
 P.38 “Using the “EXPOSURE” or “ID CARD” function quickly”
- Press this button once on the main screen (Fax) to send a fax to multiple destinations. Available only when the Fax Unit (optional) is installed.

**19. △ button**

Press this button on the menu screen to move to the item above. If you press this button when the top menu item is highlighted, you will move to the bottom menu item.

**20. ▽ button**

Press this button on the menu screen to move to the item below. If you press this button when the bottom menu item is highlighted, you will move to the top menu item.

**21. ◀ button**

Press this button once on the main screen (Copy) to show the “ORIGINAL MODE” screen. Press this button on the menu screen to move to one upper layer of the item or to decrease the setting value.

 P.38 “Selecting “ORIGINAL MODE” quickly”

**22. [CANCEL] button**

Cancels the current settings and returns to the previous item.

**23. Alert lamp**

Blinks or lights in case of an error.

**24. [DATA] lamp**

This lamp blinks while print data is being received or fax data is being sent and received.

**25. LCD screen**

Confirms each menu and error messages.

 P.17 “Main screen (Copy)”

**26. [DRAWER] button/lamps**

Use this button to select a drawer or the bypass tray to be used as a paper source. The lamp of the paper source currently selected is lit. The lamp blinks when the selected drawer or tray is running out of paper.

When paper in the drawer or on the bypass tray has run out, see the following page to add paper.

 P.20 “Preparation 2 - Loading Paper”



## ■ Main screen (Copy)

Appears after the power of the equipment is turned ON and the warm-up is finished. This screen is called “main screen (Copy)”. This screen also appears when the AUTO CLEAR function has worked.

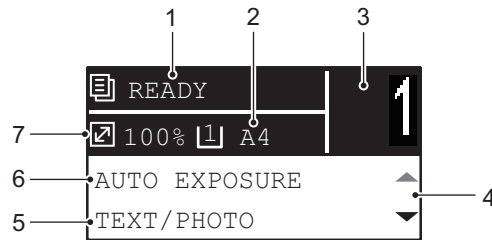

- 1. Message**  
Displays the current status or error messages.
- 2. Paper size**  
Displays the paper size specified for the drawer or the bypass tray.
- 3. Copy quantity**  
Displays the number of copies.
- 4. Scroll icon**  
Displays  $\triangle$  or  $\nabla$  that you can press on the current screen or menu.
- 5. Original mode**  
Displays the mode to copy the original.
- 6. Exposure**  
Displays the copy density.
- 7. Reproduction ratio**  
Displays the reproduction or zoom ratio to copy.

### Tip

This function returns all settings to default without the need to press [FUNCTION CLEAR] on the control panel. It works when a specified period of time has passed since the last paper exit or the last entry of any button.

P.174 “GENERAL”

## Preparation 1 - Turning Power ON

### ■ Turning on

- 1 Press the power switch to “|” (on).

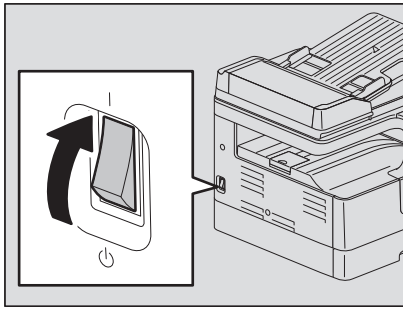

Starts warming up. When the warm-up has finished, the equipment is ready.



#### Tip

If you press [START] during the warm-up, copying automatically starts after it has finished. When the job is reserved, “COPYING” appears on the LCD screen to show you the current status. This function cannot be accessed while “PLEASE WAIT” is being displayed.

- 2 The LCD screen below is shown if the equipment is managed under the department code function.

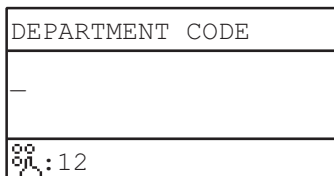

Key in a 5-digit department code, and then press [OK].

#### Tip

If the department code function is enabled, press [FUNCTION CLEAR] after any operation to prevent unauthorized use of the equipment.

For the details of the department code, see the following page:

P.183 “Department Management”

### □ Turning off

Press the power switch to “” (off).

## ■ Saving energy when not in use - Energy saving mode -

To reduce power consumption, the equipment automatically enters into the energy saving mode when a specified period of time has passed since its last use.

### □ Types of energy saving mode

**Low power mode:** “SAVING ENERGY” appears on the LCD screen.

The equipment automatically enters into low power mode when a specified period of time elapses.

**Sleep mode:** The LCD screen is turned off and only [ENERGY SAVER] is lit.

The equipment enters into sleep mode when a specified period of time elapses or the [ENERGY SAVER] button is pressed.

#### Note

- When “Status Monitor” is running, the equipment does not enter into the sleep mode. If you want to enable the sleep mode, exit it out.  
 ☞ P.75 “Status Monitor”
- This equipment does not enter sleep mode when the Wireless LAN Module is installed.

#### Tip

The timers for “AUTO POWER SAVE” and “SLEEP MODE” have been set respectively as the factory default settings. You can change them in the “USER FUNCTIONS” menu.

☞ P.171 “User Functions Menu List”

### □ To turn the equipment into the energy saving mode (Sleep mode) manually

Press [ENERGY SAVER].

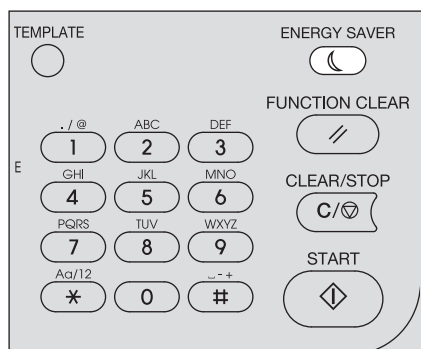

#### Canceling conditions for energy saving mode

The energy saving mode is canceled under the following conditions.

- When [ENERGY SAVER], [START], [COPY], [SCAN], or [FAX] on the control panel is pressed.
  - For the low power mode: Press [ENERGY SAVER], [START], [COPY], [SCAN], or [FAX]
  - For the sleep mode: Press [ENERGY SAVER]

#### Note

Press [ENERGY SAVER] for at least 0.5 seconds.

- When printing or scanning is performed from a PC connected with this equipment.
- When fax data is received.

## Preparation 2 - Loading Paper

Load an appropriate type of paper.

### ■ Acceptable paper types

Acceptable paper types differ depending on its paper source. See the table below for more details.

Paper source	Paper type	Paper size	Maximum sheet capacity <sup>*1</sup>
Drawer	Plain paper (64 - 80 g/m <sup>2</sup> , 17 - 20 lb. Bond)	A/B format: A3, A4, A4-R, A5-R, B4, B5, B5-R, FOLIO LT format: LD, LG, LT, LT-R, ST-R, COMP, 13"LG, 8.5"SQ K format: 8K, 16K, 16K-R	250 sheets (80 g/m <sup>2</sup> , 20 lb. Bond)
Paper Feed Unit	Plain paper (64 - 80 g/m <sup>2</sup> , 17 - 20 lb. Bond)	A/B format: A3, A4, A4-R, A5-R, B4, B5, B5-R, FOLIO LT format: LD, LG, LT, LT-R, ST-R, COMP, 13"LG, 8.5"SQ K format: 8K, 16K, 16K-R	250 sheets (80 g/m <sup>2</sup> , 20 lb. Bond)
Paper Feed Pedestal	Plain paper (64 - 80 g/m <sup>2</sup> , 17 - 20 lb. Bond)	A/B format: A3, A4, A4-R, A5-R, B4, B5, B5-R, FOLIO LT format: LD, LG, LT, LT-R, ST-R, COMP, 13"LG, 8.5"SQ K format: 8K, 16K, 16K-R	550 sheets (80 g/m <sup>2</sup> , 20 lb. Bond)
Drawer Module			
Bypass tray	Plain paper (64 - 80 g/m <sup>2</sup> , 17 - 20 lb. Bond)	A/B format: A3, A4, A4-R, A5-R, B4, B5, B5-R, FOLIO LT format: LD, LG, LT, LT-R, ST-R, COMP, 13"LG, 8.5"SQ K format: 8K, 16K, 16K-R	100 sheets (80 g/m <sup>2</sup> , 20 lb. Bond)
	Thin paper <sup>*2</sup> (52 - 63 g/m <sup>2</sup> , 14 - 16 lb. Bond)		1 sheet (52 - 63 g/m <sup>2</sup> , 14 - 16 lb. Bond)
	Thick paper <sup>*2</sup> (81 - 105 g/m <sup>2</sup> , 21 - 28 lb. Bond)	Non-standard size <sup>*8</sup> : Length: 100 - 297 mm (3.9" - 11.7"), Width: 148 - 432 (5.8" - 17")	10 sheets (81 - 105 g/m <sup>2</sup> , 21 - 28 lb. Bond)
	Thick paper 1 <sup>*2</sup> (106 - 163 g/m <sup>2</sup> , 29 lb. Bond - 90 lb. Index)		10 sheets (106 - 163 g/m <sup>2</sup> , 29 lb. Bond - 90 lb. Index)
	Thick paper 2 <sup>*2</sup> (164 - 216 g/m <sup>2</sup> , - 80 lb. Cover, - 110 lb. Index)		10 sheets (164 - 216 g/m <sup>2</sup> , - 80 lb. Cover, - 110 lb. Index)
	Tracing paper <sup>*2 *7</sup> (75 g/m <sup>2</sup> , 20 lb. Bond)		1 sheet
	Sticker labels <sup>*2 *3</sup>		1 sheet
	Transparencies <sup>*2 *4</sup>	A4/LT only	1 sheet
	Envelope <sup>*2 *5 *6</sup>	DL (110 mm x 220 mm), COM10 (4 1/8" x 9 1/2"), Monarch (3 7/8" x 7 1/2"), CHO-3 (120 mm x 235 mm), YOU-4 (105 mm x 235 mm)	1 sheet

\*1 "Maximum sheet capacity" refers to the maximum number of sheets when recommended paper is used. See the following page for the recommended paper:  P.21 "Recommended paper"

\*2 2-sided copying is not available.

\*3 Only sticker labels whose backing paper is not cut off are allowed.

\*4 Be sure to use the recommended overhead transparencies. Using other transparencies could cause an equipment malfunction.

\*5 Printing on the back side of an envelope is not possible.

\*6 Envelope can be used when printing from your PC.

\*7 For printing the tracing paper, select "THICK1" as the media type.

\*8 When loading the paper the size other than standard ones on the bypass tray, select "CUSTOM" as paper size.

#### Note

- Do not mix various paper sizes in one drawer.
- "LT format" is the standard size for only use in North America.
- "K format" is a Chinese standard size.
- 2-sided copying is only available for plain paper.

#### Tip

Abbreviations for LT format sizes:

LT: Letter, LD: Ledger, LG: Legal, ST: Statement, COMP: Computer

## ■ Recommended paper

To ensure the best copy performance, the paper types listed below are recommended. If you want to use paper other than that we recommend, contact your service technician.

Paper type	Product name	
Plain paper	A/B format: TGIS Paper/Mondi LT format: TIDAL/Hammermill	80 g/m <sup>2</sup> , 20 lb. Bond
	K format: Classic Jetset COPY PAPER/ UPM	70 g/m <sup>2</sup>
Thick paper	A/B format: Color Copy/Mondi LT format: Laser/Hammermill	90 g/m <sup>2</sup> , 24 lb. Bond
	A/B format: Color Copy/Mondi	100 g/m <sup>2</sup>
Thick paper 1	A/B format: Color Copy/Mondi LT format: Laser/Hammermill	120 g/m <sup>2</sup> , 32 lb. Bond
	A/B format: Color Copy/Mondi LT format: Exact Index/WAUSAU	160 g/m <sup>2</sup> , 90 lb. Index
Thick paper 2	A/B format: Color Copy/Mondi LT format: Laser/Hammermill	200 g/m <sup>2</sup> , 80 lb. Cover
	A/B format: Color Copy/Mondi LT format: Exact Index/WAUSAU	200 g/m <sup>2</sup> , 110 lb. Index
Tracing paper	Tracing paper/Ostrich International	75 g/m <sup>2</sup> , 20 lb. Bond
Sticker labels	A/B format: 3478/ZWECK-AVERY LT format: 5165/AVERY	
Transparencies <sup>*1</sup>	A/B format: PP2500/3M LT format: X10.0/FOLEX	
Envelope	ColumbianCO138/Westvaco, No.553/Monarch/mailwell	

\*1 Be sure to use the recommended overhead transparencies. Using other transparencies could cause an equipment malfunction.

## ❑ Paper types not acceptable

Do not use the types of paper listed below since they may cause paper misfeeds or an equipment malfunction. If you use these types of paper, paper misfeeding may occur frequently, a paper misfeeding in which you cannot easily remove paper from this equipment may occur, or images may continually become dirty.

- Damp paper
- Creased paper
- Wrinkled paper or paper prone to be curled
- Extremely smooth or rough surface paper
- Paper whose surface has had special treatment
- Paper once printed or used on one side
- Sticker labels shown below
  - The released paper is visible since its label has been punched out.
  - The released paper is visible since a part of its label has peeled off.
  - A sticker label which has been cut

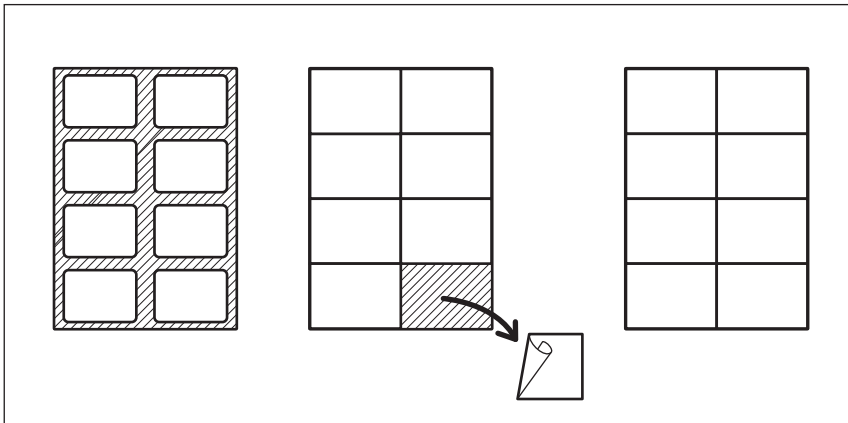

## ❑ Storing paper

Note the following points when storing paper.

- Wrap the paper in its packaging to prevent it from gathering dust.
- Do not expose the paper to direct sunlight.
- Do not store the paper in a humid location.
- Store the paper on a flat surface to prevent it from becoming curled or creased.

## ■ Loading paper in the drawer/Paper Feed Unit

You can load paper in the drawer and Paper Feed Unit in the same procedure.

For the acceptable paper, see the following page:

📖 P.20 “Acceptable paper types”

**1 Turn the power of the equipment ON.**

**2 Pull out the drawer carefully.**

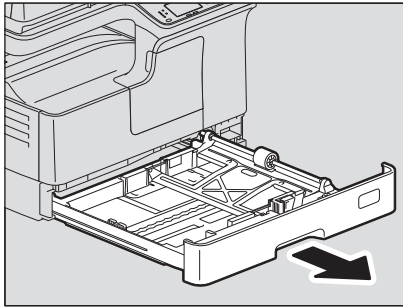

**3 Press down the paper plate.**

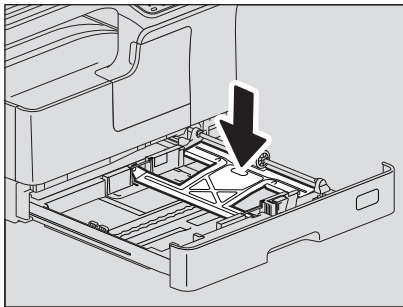

### Note

Press it down until you hear a click sound and it is no longer lifted up.

**4 Load paper face up in the drawer.**

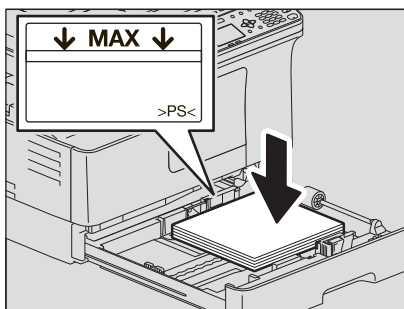

### Note

- Up to 250 sheets (80 g/m<sup>2</sup> or 20 lb. Bond) can be loaded. Be sure that the height of the stacked paper does not exceed the line indicated inside of the side guides.  
📖 P.20 “Acceptable paper types”
- Fan the paper well before loading it in the drawer, otherwise multiple feeding could occur. Be careful not to cut your fingers.
- The printable side may be noted on its packaging.
- Never put anything in a vacant space in the drawer after the paper has been loaded. Otherwise, it may cause paper misfeeds or an equipment malfunction.
- If paper cannot be fed, printing takes a long time after feeding or the quality is poor, turn over the paper and place it again.

### When placing LD size paper

To place LD size paper in the drawer, the end guide needs to be removed. Move it to the left end while pushing its lower part from both sides, and then pull it upward. Keep it in the pocket on the front side of the drawer.

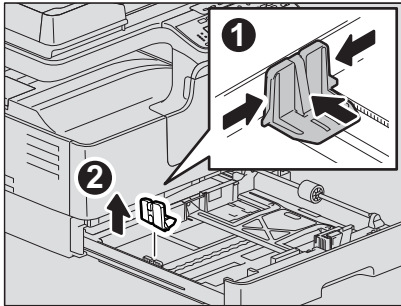

- 5** Move the end guide to the trailing edge of the paper while pushing its lower part in the direction of the arrows.

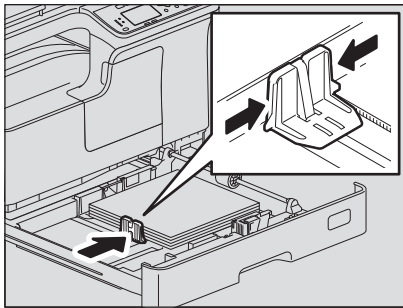

#### Note

Do not allow any gap between the paper and the end guide in the drawer.

- 6** While holding the green lever of the front side guide, adjust the side guides to the paper size.

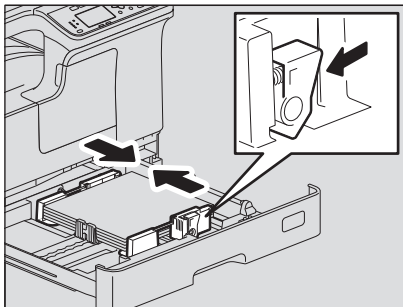

- 7** Push the drawer straight into the equipment slowly until it stops.

#### ⚠ CAUTION

**Do not catch your fingers in the drawer when closing it.**

This could cause injury.

#### Register the paper size into the equipment.

When you load paper in the drawer for the first time, register the paper size. Be sure to register it correctly, otherwise it could cause a paper misfeed.

For the registration, see the following page:

📖 P.32 “Preparation 3 - Registering Paper Size and Type”

#### Note

Be sure to register the paper size each time you have changed it.



## ■ Loading paper in the drawers of Paper Feed Pedestal

For the acceptable paper, see the following page:

📖 P.20 “Acceptable paper types”

- 1 Turn the power of the equipment ON.**
- 2 Pull out the drawer carefully.**

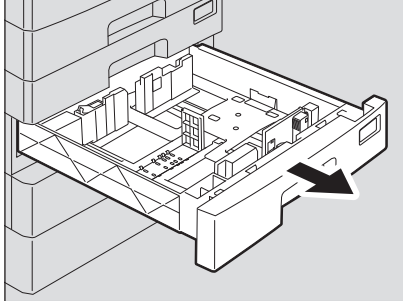

- 3 Pull out the trailing guide while pushing its lower part to the direction of the arrow. Then reinstall the guide at the position of the desired paper size.**

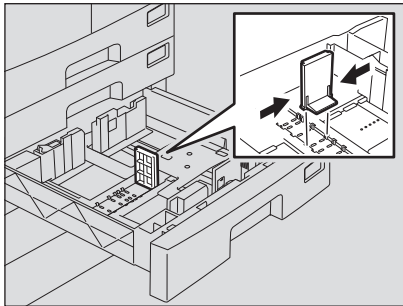

### Tip

The paper size is indicated on the bottom inner surface of the drawer.

- 4 Push the right side of the side guide lock to unlock it.**

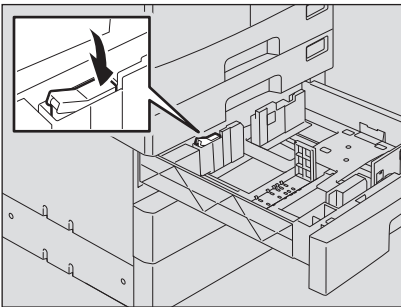

- 5 While pushing the green knob of the side guides, adjust the side guides at the position of the desired paper size.**

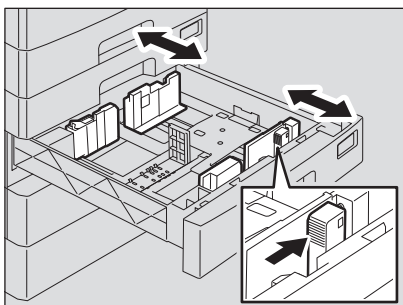

**Note**

Adjust the side guides with both hands.

**6 Load paper face up in the drawer.**

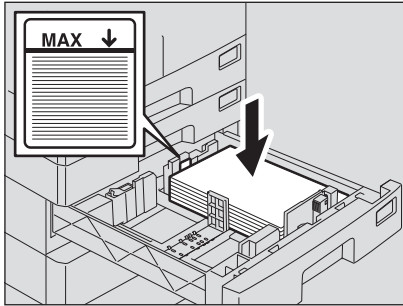

**Note**

- Up to 550 sheets (80 g/m<sup>2</sup> or 20 lb. Bond) can be loaded. Be sure that the height of the stacked paper does not exceed the line indicated inside of the guide.  
📖 P.20 “Acceptable paper types”
- Fan the paper well before loading it in the drawer, otherwise multiple feeding could occur. Be careful not to cut your fingers.
- Place the paper face up. The printable side may be noted on its packaging.
- Never put anything in a vacant space in the drawer after the paper has been loaded. Otherwise, it may cause paper misfeeds or an equipment malfunction.

**7 Adjust the side guides.**

Be sure that a gap of approx. 0.5 mm (0.02") (1.0 mm (0.04") or less in total) is left between the paper and each side guide (shown as “A” in the picture). If the gap is inappropriate, this could cause a paper misfeed.

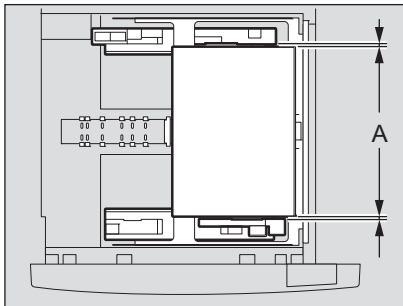

**8 Push the left side of the side guide lock to lock it.**

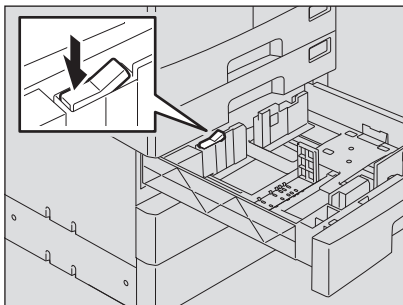

## ■ Loading paper on the bypass tray

### Note

The contents of the original(s) are rotated when they are placed on the Reversing Automatic Document Feeder and copied on paper of the following sizes fed from the bypass tray.

A/B format: A3, A4-R, A5-R, B4, B5-R, FOLIO

LT format: LD, LG, LT-R, ST-R, COMP, 13"LG, 8.5"SQ

K format: 8K, 16K-R

For example, to copy an A5-size original, place the original on the Reversing Automatic Document Feeder in A5 portrait orientation and paper on the bypass tray in A5 landscape orientation (A5-R).

To enlarge an A4-size original to A3, place the original on the Reversing Automatic Document Feeder in A4 portrait orientation and A3 paper on the bypass tray.

The illustrations below are example of loading A4/LT size paper.

For the acceptable paper, see the following page:

📖 P.20 “Acceptable paper types”

### 1 Open the bypass tray.

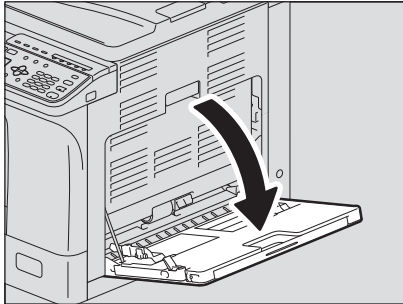

### 2 Pull the paper holding lever out, and then load paper face down and straight on the bypass tray.

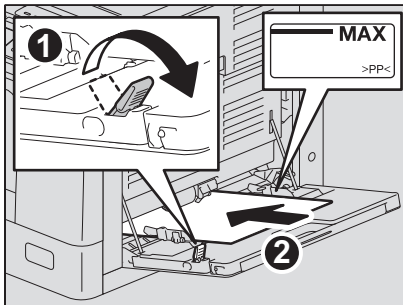

### Note

The printable side may be noted on its packaging.

### 3 Align the side guides with the edges of the paper, and then push back the lever.

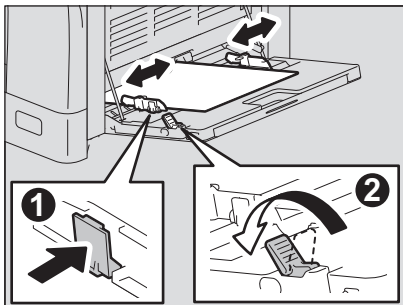

#### Note

- Up to 100 sheets of plain paper (80 g/m<sup>2</sup> or 20 lb. Bond) can be loaded. Be sure that the height of the stacked paper does not exceed the indicators of the side guides. If paper other than plain is used, set it one sheet at a time.
- Fan the paper well before loading it on the bypass tray, otherwise multiple feeding could occur. Be careful not to cut your fingers.
- Do not push the paper forcibly into the entrance of the bypass feeder, otherwise it could cause a paper misfeed.
- Flatten curled paper before loading it on the bypass tray. If the paper is greatly curled, paper feeding sometimes starts while the paper is being set.
- If paper remains on the bypass tray when loading additional paper on it, release the lever, then remove all the paper, and then load it again.

#### Tip

- When you use paper longer than the bypass tray size, pull out the paper holder from the tray.

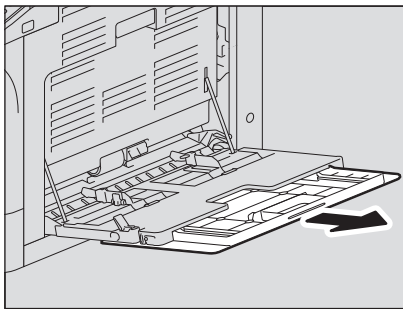

- Depending on its condition, paper may not be fed for bypass copying. In this case, turn over the paper and place it again as shown in the figure.

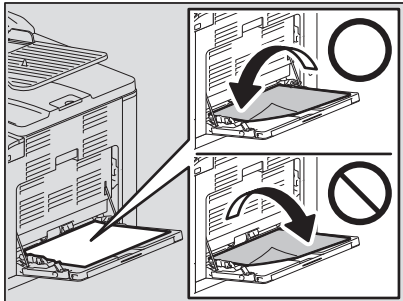

## ■ Loading an envelope on the bypass tray

For the acceptable envelope sizes, see the following page:

📖 P.20 “Acceptable paper types”

### Notes for using envelopes

Do not use the following envelopes, otherwise they may cause a paper misfeed or damage to the equipment.

1. Badly curled, wrinkled or folded envelopes
2. Extremely thick or thin envelopes
3. Wet or damp envelopes
4. Torn envelopes
5. Envelopes which include the contents
6. Non-standard size envelopes (ones with a special shape)
7. Envelopes with eyelets or windows
8. Envelopes sealed with adhesive paste or tape
9. Partly-opened or perforated envelopes
10. Envelopes with special coating on the surface
11. Envelopes with glue or double-sided adhesive tape

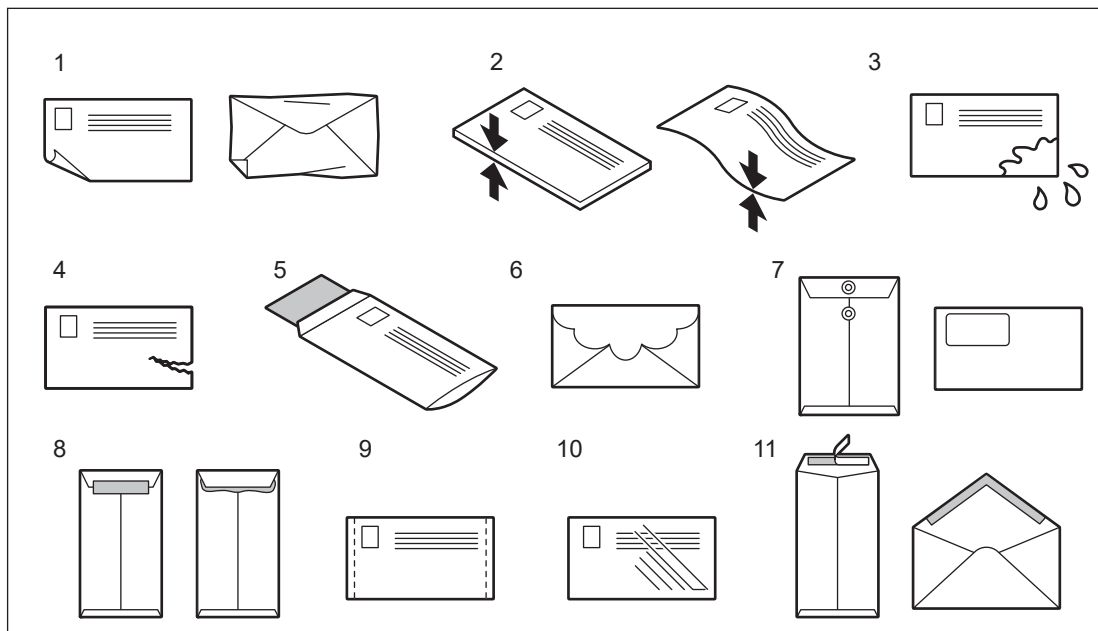

### Note

- Store envelopes at room temperature and away from heat and moisture.
- Paper wrinkling may occur after printing depending on environment or the envelope type or condition. We recommend printing paper as a sample before doing so in large amounts.

**1 Place an envelope on a flat clean surface and press it with your hands in the arrow directions as shown below to expel air from the inside.**

Press it well to prevent the flap from rolling upward.

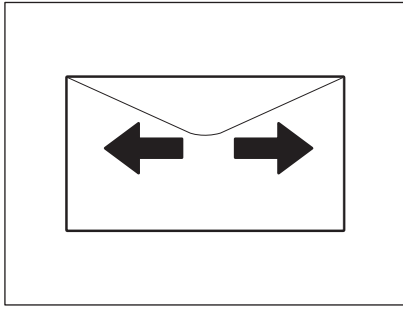

Correct bent corners of the envelope.

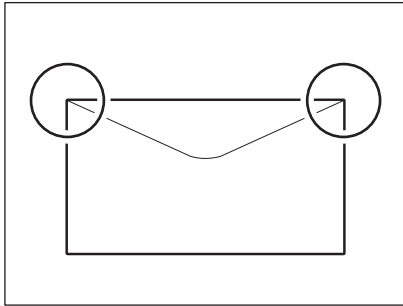

**2 Open the bypass tray.**

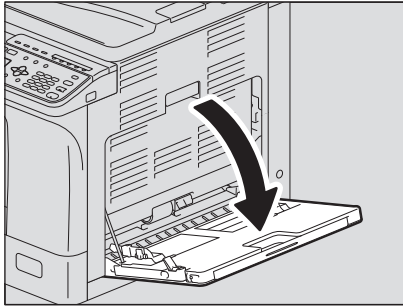

**3 Pull the paper holding lever out, and then load the envelope face down on the bypass tray.**

Place the envelope with its flap side at the front as shown below.

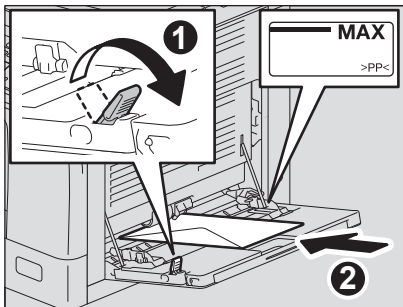

**Note**

- Do not copy or print on the back of envelopes, otherwise it may cause a paper misfeed or soil them or the inside of the equipment.
- Printing may be uneven depending on the envelope types.

**4** Align the side guides to the edges of the envelope, and then push back the lever.

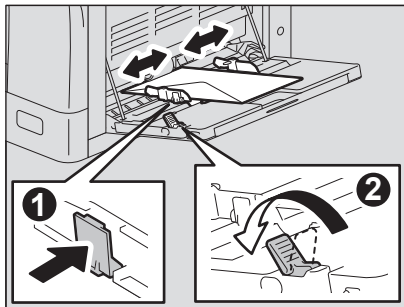

## Preparation 3 - Registering Paper Size and Type

---

When you load or change paper, a pop-up window appears. Follow the instructions to register the items below in the equipment.

- For the drawer: the paper size
- For the bypass tray: the paper size and type

### Tip

- You can also register the paper size for the drawer in the “USER FUNCTIONS” menu.  
 P.171 “User Functions Menu List”
- When loading the paper the size other than standard ones on the bypass tray, select “CUSTOM” as paper size.



## COPY FUNCTIONS

<b>Basic Copy Procedure .....</b>	<b>34</b>
Acceptable originals .....	34
Copying originals .....	35
<b>Copy Settings.....</b>	<b>40</b>
Adjusting the exposure.....	40
Selecting the original mode .....	41
Selecting the paper.....	42
Enlarging or reducing the copy size.....	44
Sorting pages .....	49
Copying two or four pages on each sheet .....	51
Copying both sides of a card on a sheet .....	53
Erasing the shadow on edges.....	55
Copying right and left pages separately .....	56
Shifting the pages to the right or left.....	57
Copying on one or both sides.....	58
Adding a page number and date/time on the copied paper .....	61
Removing blank pages .....	61
Copying different sizes in one go .....	62
Image direction .....	63
Continuing the scanning for a copy .....	64
<b>Using Templates (Copy) .....</b>	<b>65</b>
Registering the templates .....	65
Recalling a template .....	66

## Basic Copy Procedure

Learn the basic copy procedure in this section. For the other various functions, see the following page:

 P.40 “Copy Settings”

Make sure that the equipment is ready to copy.

 P.18 “Preparation 1 - Turning Power ON”

 P.20 “Preparation 2 - Loading Paper”

 P.32 “Preparation 3 - Registering Paper Size and Type”

### ■ Acceptable originals

Acceptable originals differ depending on the setting position. See the table below for more details.

If you are using the Reversing Automatic Document Feeder, you can automatically scan a stack of plain paper originals at one time.

Setting position	Type	Maximum size	Acceptable sizes for automatic size detection	Maximum number of sheets
Original glass	Plain paper Special paper Booklets	A3 or LD	Other than North America and China: A3, A4, A4-R, A5, A5-R, B4, B5, B5-R North America: LD, LG, LT, LT-R, ST, ST-R China: A3, A4, A4-R, A5, A5-R, B4, B5, B5-R, 8K, 16K, 16K-R	-
Reversing Automatic Document Feeder	Plain paper Thin paper Thick paper (50 - 104 g/m <sup>2</sup> , 13 - 27 lb. Bond)		Other than North America and China: A3, A4, A4-R, A5-R, B4, B5, B5-R North America: LD, LG, LT, LT-R, ST-R, COMP China: A3, A4, A4-R, A5-R, 8K, 16K, 16K-R	50 sheets (80 g/m <sup>2</sup> , 20 lb. Bond) (or stack height 9.5 mm) <sup>*1</sup>

\*1 The maximum number of sheets acceptable varies depending on the type of original.

### □ Maximum number of originals scanned at one time

When you use “CONTINUE SCAN” with the Reversing Automatic Document Feeder (RADF), you can scan up to 150 original sheets at one time. When the number of sheets to be scanned exceeds 150 or the built-in memory in the equipment is full, scanning stops and an error message is displayed on the LCD screen. Press any button on the control panel to delete the scanned data.

### □ Precautions for Reversing Automatic Document Feeder

Do not use the following types of original as they may cause a paper misfeed or damage to the equipment:

- Originals that are folded or curled
- Originals with carbon copies
- Originals that have been taped, pasted, or cut-out
- Originals that have been clipped or stapled
- Originals with holes or tears
- Originals that are damp
- Originals whose correction fluid or ink has not been dried completely
- Overhead transparencies or tracing paper
- Coated paper (e.g. coated with wax)
- Originals with multiple holes punched (e.g. loose leaf paper)

The following types of originals can be used but need extra care:

- Originals that you cannot slide with your fingers or whose surface is specially treated: They should be fanned well before loading since they may not be able to be separated from each other at feeding.
- Originals that are folded or curled: They should be smoothed out before being loaded.

**When black streaks appear**

If the scanning area or the guide area is dirty, image problems such as black streaks may occur. Weekly cleaning of these areas is recommended.

📖 P.208 “Regular Cleaning”

■ **Copying originals**

Follow the common basic instructions below to make a copy.

**1 Place the original(s).**

**Placing originals on the original glass**

1. Raise the Platen Cover or the Reversing Automatic Document Feeder.
2. Place the original face down on the original glass.
3. Align the original with the top-left corner of the original glass.
4. Lower the Platen Cover or the Reversing Automatic Document Feeder carefully.

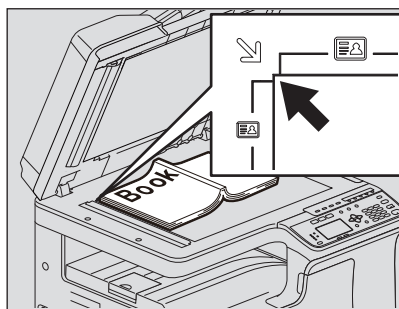
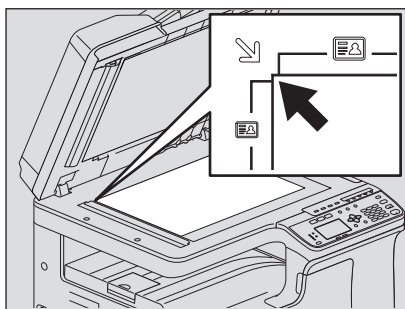

**⚠ CAUTION**

**Do not place heavy objects (4 kg/9 lb. or over) on the original glass and do not force it down.**  
It may break the glass and could cause injury.

**Note**

- When you copy originals with folds or wrinkles, smooth out the folds and wrinkles first. Then, place the original on the original glass and close the Platen Cover or the Reversing Automatic Document Feeder to start copying.
- If a shadow of the folds or wrinkles appears on copies although you smooth out them, adjust the exposure or use the “BACKGROUND ERASE” function.
- When you place a booklet-type original, strong light may leak out during copying. Do not look directly at the original glass.
- When you place a thick booklet, do not close the Platen Cover or the Reversing Automatic Document Feeder forcefully; you can still make copies without closing the cover or feeder.
- If lights from lighting devices or outside light are applied to the original glass, the original size may not be detected correctly. In this case, specify the original size.  
📖 P.44 “Enlarging or reducing the copy size”

**Tip**

When you use the transparent original such as overhead transparencies and tracing paper, place a blank plain sheet of paper - the same size or a larger sheet - over the original, otherwise the copied image could be stained.

## Placing originals on the Reversing Automatic Document Feeder

1. Align all the originals.
2. Place them face up and align the side guides to the original length.

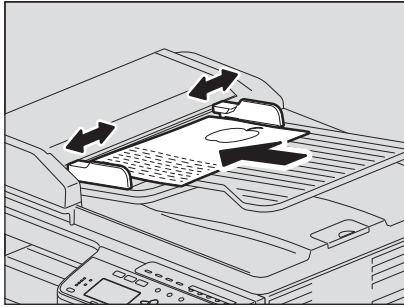

### Note

- The top sheet of the originals will be scanned first.
- Do not load more than 50 originals (80 g/m<sup>2</sup>, 20 lb. Bond) at once, and make sure the thickness of the stack of originals does not exceed 9.5 mm regardless of their size.
- Flatten curled paper before loading it on the Reversing Automatic Document Feeder.
- To prevent long originals (A3, B4, A4-R, LD, LG, COMP, or 8K) from sliding out, raise the paper exit stopper. When you have finished using the stopper, lift it slightly and slide it back in.

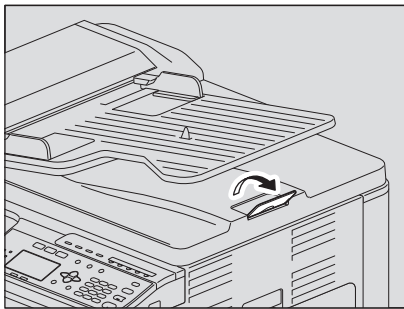

- To prevent misfeeding, do not leave originals or turn OFF/ON the equipment with originals on the Reversing Automatic Document Feeder.

## 2 Press [COPY].

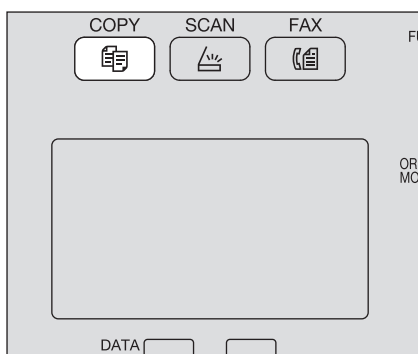

### 3 Enter the number of copies with the digital keys.

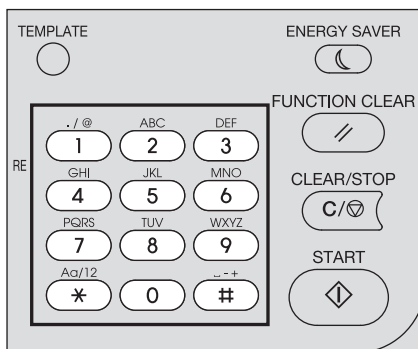

### 4 Make the copy settings as required.

P.40 “Copy Settings”

#### Note

You may not be able to use some combinations of functions.

P.217 “Copying Function Combination Matrix”

### 5 Press [START] to start copying.

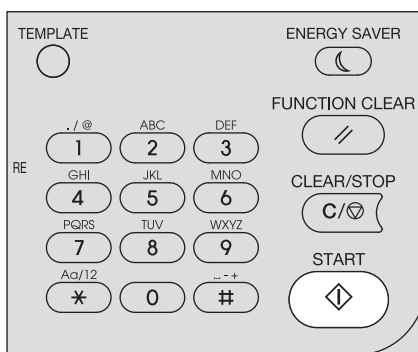

To stop or resume copying, press [CLEAR/STOP] during copying.

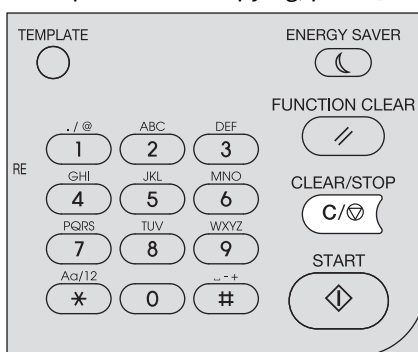

Press [OK] or [CANCEL] according to the message displayed on the LCD screen.

When you copy loading originals from the Reversing Automatic Document Feeder (RADF):

If there are more originals, place the next ones, select “SCAN NEXT” using  $\nabla$  or  $\triangle$  and press [OK]. If there are no more originals, select “FINISHED” using  $\nabla$  or  $\triangle$  and press [OK]. (Only when “CONTINUE SCAN” is set to “ON”)

#### Note

If originals remain on the Reversing Automatic Document Feeder after pressing [FINISHED] on the CONTINUE SCAN screen, remove all the originals. Leaving them may cause a paper jam.

When the copying has finished, press [FUNCTION CLEAR] to clear the set copy functions and return to the main screen (Copy).

## Note

- If the paper source runs out of paper, an error message is displayed on the LCD screen and copying stops. Load paper. The equipment automatically resumes copying after approx. 3 seconds have passed.
- The receiving tray can hold up to 100 sheets. If the excessive paper error occurs, the lamp blinks and an error message is displayed on the LCD screen. Remove the paper from the tray and press [START] to resume copying.
- When you use overhead transparencies, remove them one by one every time they are ejected. Otherwise, they could be curled and not be good for projection.

## Shortcut keys

You can access some functions by simply pressing the  $\triangleright$  and  $\triangleleft$  button.

P.38 “Using the “EXPOSURE” or “ID CARD” function quickly”

P.38 “Selecting “ORIGINAL MODE” quickly”

### Using the “EXPOSURE” or “ID CARD” function quickly

On the first screen of Copy mode, the  $\triangleright$  button function varies depending on the region. It can work as the [EXPOSURE] button for Europe and the Americas, or the [ID CARD] button for regions other than Europe and the Americas. Just press the button to access the “EXPOSURE” or “ID CARD” function so that you can change the copy density, or you can copy the front and back of a card on a sheet of paper.

P.40 “Adjusting the exposure”

P.53 “Copying both sides of a card on a sheet”

#### For Europe and the Americas

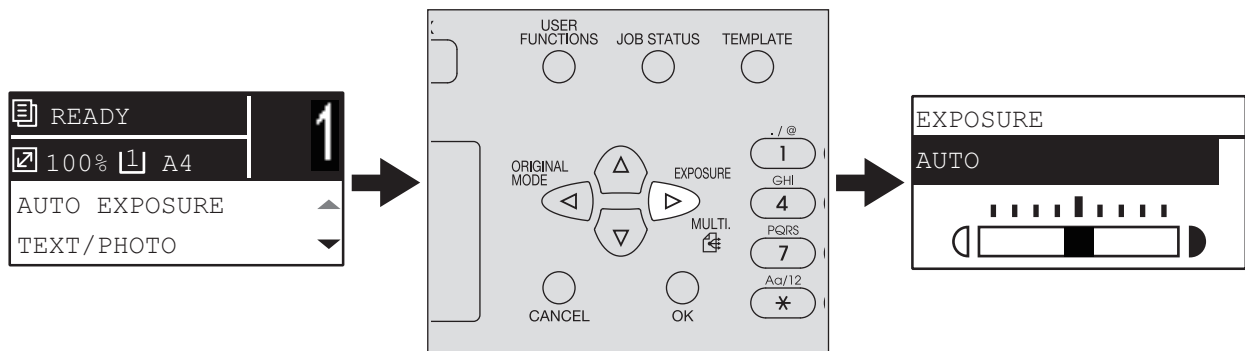

#### For regions other than Europe and the Americas

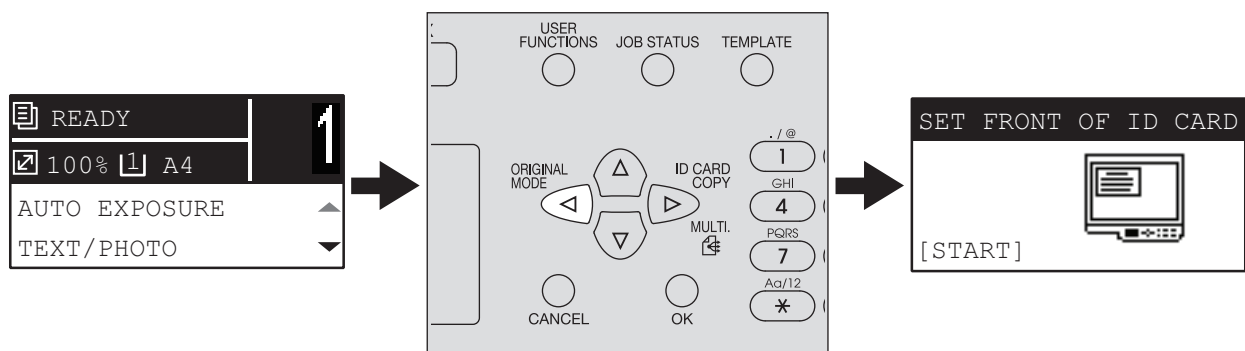

### Selecting “ORIGINAL MODE” quickly

On the first screen of Copy mode, the  $\triangleleft$  button can work as the [ORIGINAL MODE] button. Just press the button to access the “ORIGINAL MODE” function so that you can change the original mode.

P.41 “Selecting the original mode”

**For Europe and the Americas**

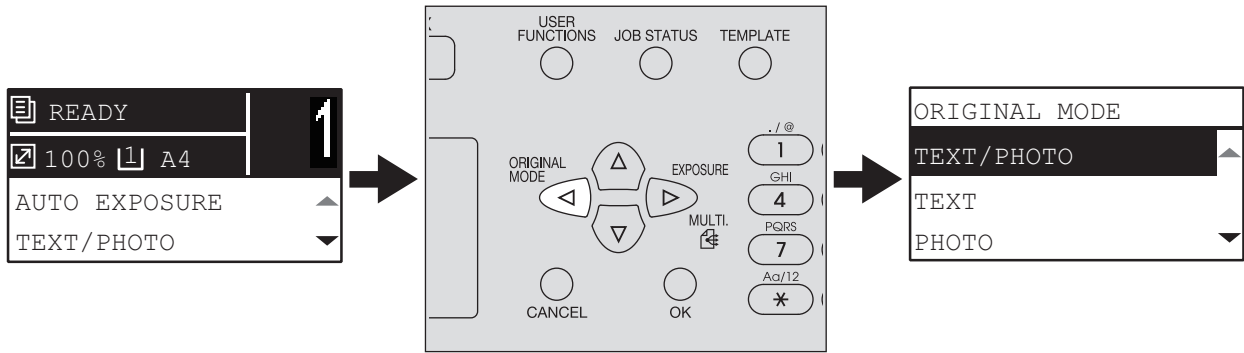

**For regions other than Europe and the Americas**

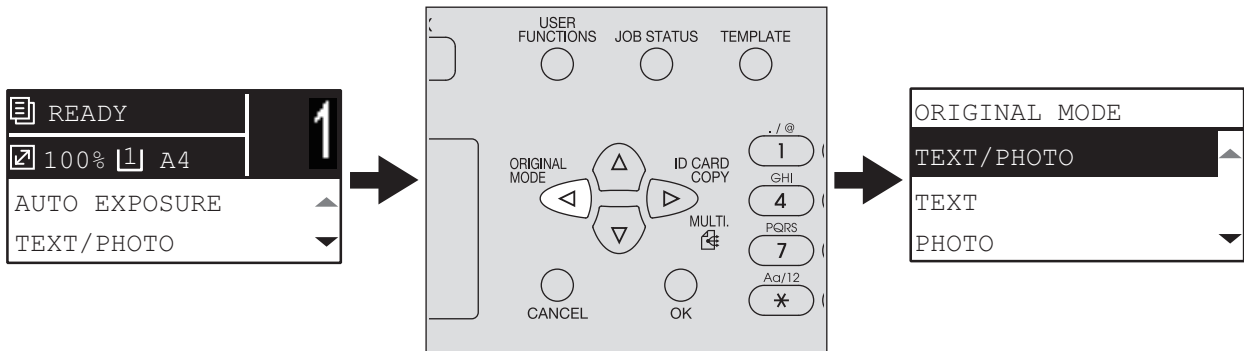

## Copy Settings

You can make the copy settings on the copy functions menu.

### Tip

Press [CANCEL] to exit from the setting without making any changes.

## ■ Adjusting the exposure

You can adjust the density to make copies lighter or darker in nine levels from -4 to +4. The auto density setting can represent the copy image in the optimal density.

### Tip

You can directly access this function by pressing  $\triangleright$ . The button operation varies depending on the region.  
For Europe and the Americas:

 P.38 “Using the “EXPOSURE” or “ID CARD” function quickly”



Menu Functions	Settings	Description
EXPOSURE	AUTO	Adjusts the density automatically.
	Manual	Adjusts the density manually.

- 1 Press [COPY].
- 2 Press  $\nabla$  or  $\triangle$  to select the item displayed on the LCD screen, and then press  $\triangleright$ .
- 3 Press  $\nabla$  or  $\triangle$  to select the setting item.
- 4 Adjust the density as follows.  
**For “AUTO”:**  
Press [OK].  
**For manual:**
  1. Press  $\triangleright$  or  $\triangleleft$  to increase or decrease the density level.
  2. Press [OK].



## ■ Selecting the original mode

You can achieve the optimal image quality by selecting a suitable original mode.

Tip

You can directly access this function by pressing ◀.

📖 P.38 “Selecting “ORIGINAL MODE” quickly”



Menu Functions	Settings	Description
ORIGINAL MODE	TEXT/PHOTO	Text and photographs mixed.
	TEXT	Text only or text and fine illustration only.
	PHOTO	Photographs only.
	BACKGROUND ERASE	Dark background is placed.

- 1 Press [COPY].
- 2 Press ▼ or ▲ to select the item displayed on the LCD screen, and then press ▶.
- 3 Press ▼ or ▲ to select the setting item, and then press [OK].

## ■ Selecting the paper

You can select the paper source in which the paper of the desired size and type is loaded.

📖 P.20 “Acceptable paper types”

### □ Selecting the paper source



Menu Functions	Settings	Description
<b>DRAWER</b>	<b>Drawer 1 XX, Drawer 2 XX, Drawer 3 XX, Drawer 4 XX</b>	Uses the drawer as the paper source. The variable “XX” indicates the paper size.
	<b>Bypass XX</b>	Uses the bypass tray as the paper source. Available only when the paper is loaded on the bypass tray. The variable “XX” indicates the paper size.
	<b>APS</b>	Automatic Paper Selection. Detects the size of the original and selects paper of the same size automatically.
	<p><b>Note</b></p> <p>This function may not work properly for totally dark originals or originals with dark borders.</p> <p><b>Tip</b></p> <p>For the detectable original sizes, see the following page: 📖 P.34 “Acceptable originals”</p>	

- 1** Press [COPY].
- 2** Press ▾ or ▲ to select the item displayed on the LCD screen, and then press ▷.
- 3** Press ▾ or ▲ to select the setting item.
  - To select the paper size:**
    1. Press ▷.
    2. Press ▾ or ▲ to select the paper size, and then press [OK].
  - To accept the setting:**

Press [OK].

## ❑ Selecting the bypass tray automatically

When you load paper into the bypass tray, the paper source automatically changes from the drawer to the bypass tray. The LCD screen automatically changes so that you can easily set the paper size and type for the bypass tray.

- 1** Press ▾ or ▲ to select the paper size, and then press [OK].

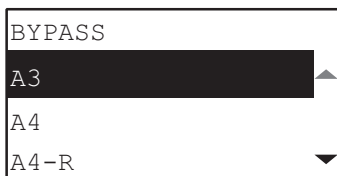

- 2** Press ▾ or ▲ to select the paper type, and then press [OK].

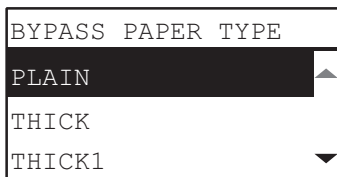

Remove the paper from the bypass tray after copying is finished. The paper source automatically changes back to the drawer.

## ■ Enlarging or reducing the copy size

You can enlarge or reduce the size of copies in the following three ways.

- Specify the ratio manually (📖 P.44)
- Select a fixed zoom ratio (📖 P.45)
- Automatic Magnification Selection (AMS) (📖 P.47)

### □ Specifying the ratio manually



Menu Functions	Settings	Description
ZOOM	<b>Manual zoom (25 - 100 - 400%)</b>	Adjusts the ratio manually.
	<b>FIXED ZOOM</b> <b>A/B format:</b> 50% (A3 -> A5), 71% (A3 -> A4), 71% (A4 -> A5), 141% (A4 -> A3), 141% (A5 -> A4), 200% (A5 -> A3), 300%, 400% <b>LT format:</b> 50% (A3 -> A5), 60% (LG -> ST), 65% (LD -> LT), 65% (LT -> ST), 78% (LD -> LG), 78% (LG -> LT), 100% (LT -> LG), 121% (LG -> LD), 129% (LT -> LD), 129% (ST -> LT), 154% (ST -> LG), 200% (ST -> LD), 300%, 400% <b>K format:</b> 50% (A3 -> A5), 54% (8K -> A5), 64% (A3 -> 16K), 69% (8K -> 16K), 71% (A3 -> A4), 71% (A4 -> A5), 76% (16K -> A5), 76% (8K -> A4), 91% (A3 -> 8K), 91% (A4 -> 16K), 108% (16K -> A4), 108% (8K -> A3), 129% (A4 -> 8K), 129% (A5 -> 16K), 138% (16K -> 8K), 141% (A4 -> A3), 141% (A5 -> A4), 152% (16K -> A3), 182% (A5 -> 8K), 200% (A5 -> A3), 300%, 400%	📖 P.45 “Selecting a fixed zoom ratio”
	<b>AMS</b>	📖 P.47 “Automatic magnification selection (AMS)”

- 1 Press [COPY].**
- 2 Press ▾ or ▲ to select the item displayed on the LCD screen, and then press ▶.**
- 3 Press ▾ or ▲ to select the setting item for manual zoom.**  
When manual zoom is already selected, this step is not necessary.

**4 Press  $\triangleright$  or  $\triangleleft$  to increase or decrease the zoom ratio, and then press [OK].**

You can keep pressing the button to adjust the ratio quickly.

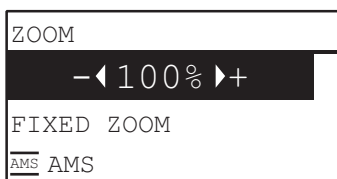

**Note**

To make an enlarged or reduced copy of an original placed in portrait direction onto a paper in landscape direction, select “AMS” for zoom ratio.

P.47 “Automatic magnification selection (AMS)”

**❑ Selecting a fixed zoom ratio**



Menu Functions	Settings	Description
ZOOM	<b>Manual zoom (25 - 100 - 400%)</b>	P.44 “Specifying the ratio manually”
	<b>FIXED ZOOM</b> <b>A/B format:</b> 50% (A3 -> A5), 71% (A3 -> A4), 71% (A4 -> A5), 141% (A4 -> A3), 141% (A5 -> A4), 200% (A5 -> A3), 300%, 400% <b>LT format:</b> 50% (A3 -> A5), 60% (LG -> ST), 65% (LD -> LT), 65% (LT -> ST), 78% (LD -> LG), 78% (LG -> LT), 100% (LT -> LG), 121% (LG -> LD), 129% (LT -> LD), 129% (ST -> LT), 154% (ST -> LG), 200% (ST -> LD), 300%, 400% <b>K format:</b> 50% (A3 -> A5), 54% (8K -> A5), 64% (A3 -> 16K), 69% (8K -> 16K), 71% (A3 -> A4), 71% (A4 -> A5), 76% (16K -> A5), 76% (8K -> A4), 91% (A3 -> 8K), 91% (A4 -> 16K), 108% (16K -> A4), 108% (8K -> A3), 129% (A4 -> 8K), 129% (A5 -> 16K), 138% (16K -> 8K), 141% (A4 -> A3), 141% (A5 -> A4), 152% (16K -> A3), 182% (A5 -> 8K), 200% (A5 -> A3), 300%, 400%	Selects a fixed zoom ratio.
	<b>AMS</b>	P.47 “Automatic magnification selection (AMS)”

**1 Press [COPY].**

**2 Press  $\nabla$  or  $\triangle$  to select the item displayed on the LCD screen, and then press  $\triangleright$ .**

---

**3** Press  $\nabla$  or  $\triangle$  to select “FIXED ZOOM”, and then press  $\triangleright$ .

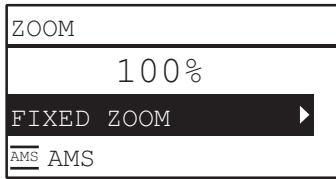

**4** Press  $\nabla$  or  $\triangle$  to select a zoom ratio, and then press [OK].

**Note**

To make an enlarged or reduced copy of an original placed in portrait direction onto a paper in landscape direction, select “AMS” for zoom ratio.

 P.47 “Automatic magnification selection (AMS)”

❑ Automatic magnification selection (AMS)



Menu Functions	Settings	Description
ZOOM	<b>Manual zoom (25 - 100 - 400%)</b>	📖 P.44 “Specifying the ratio manually”
	<b>FIXED ZOOM</b> <b>A/B format:</b> 50% (A3 -> A5), 71% (A3 -> A4), 71% (A4 -> A5), 141% (A4 -> A3), 141% (A5 -> A4), 200% (A5 -> A3), 300%, 400% <b>LT format:</b> 50% (A3 -> A5), 60% (LG -> ST), 65% (LD -> LT), 65% (LT -> ST), 78% (LD -> LG), 78% (LG -> LT), 100% (LT -> LG), 121% (LG -> LD), 129% (LT -> LD), 129% (ST -> LT), 154% (ST -> LG), 200% (ST -> LD), 300%, 400% <b>K format:</b> 50% (A3 -> A5), 54% (8K -> A5), 64% (A3 -> 16K), 69% (8K -> 16K), 71% (A3 -> A4), 71% (A4 -> A5), 76% (16K -> A5), 76% (8K -> A4), 91% (A3 -> 8K), 91% (A4 -> 16K), 108% (16K -> A4), 108% (8K -> A3), 129% (A4 -> 8K), 129% (A5 -> 16K), 138% (16K -> 8K), 141% (A4 -> A3), 141% (A5 -> A4), 152% (16K -> A3), 182% (A5 -> 8K), 200% (A5 -> A3), 300%, 400%	📖 P.45 “Selecting a fixed zoom ratio”
	<b>AMS</b>	Detects the size of the original and automatically sets the optimum zoom ratio for the paper size.
	<b>Note</b> This function may not work properly for totally dark originals or originals with dark borders.  <b>Tip</b> For the detectable original sizes, see the following page: 📖 P.34 “Acceptable originals”	

- 1 Press [COPY].
- 2 Press ▾ or ▲ to select the item displayed on the LCD screen, and then press ▶.

---

**3** Press  $\nabla$  or  $\triangle$  to select “AMS”, and then press [OK].

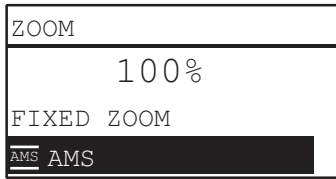

**Note**

To make an enlarged or reduced copy of an original placed in portrait direction onto a paper in landscape direction, select “AMS” for zoom ratio.

 P.47 “Automatic magnification selection (AMS)”



## ■ Sorting pages

You can sort a number of copied pages in the same order as the original.

**NON SORT:** Not to sort the copied pages. All copies of the first page are ejected first and then all copies of subsequent pages are ejected in sequence.

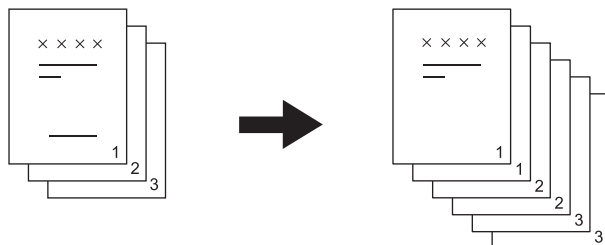

**Sort:** Sorts the copied pages in the same order as the original and eject all sets of copies in the same orientation.

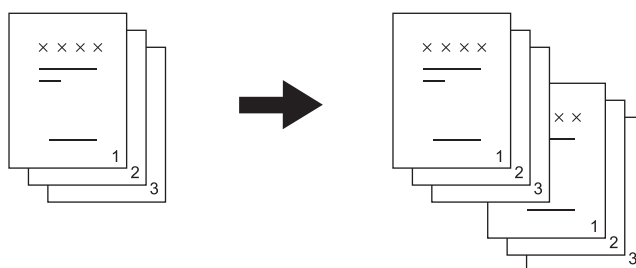

**ROTATE SORT:** When you make several sets of copies, the copies can be sorted and made to exit alternately one set by one. This is called alternation. You need to place copy paper in one paper source in a landscape direction and place that of the same size in another paper source in a portrait direction in advance.

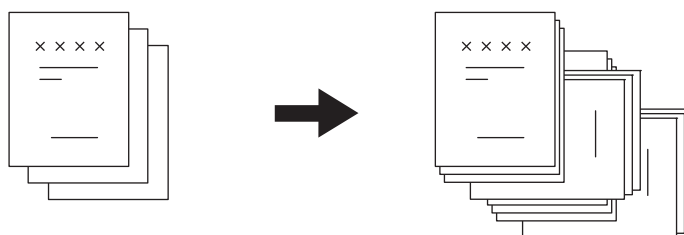

**Note**

Paper of letter, A4, B5, LT, or 16K size can be loaded in drawers or on the bypass tray for “ROTATE SORT”.

Tip

When an original is placed on the Reversing Automatic Document Feeder, “SORT” is automatically set.

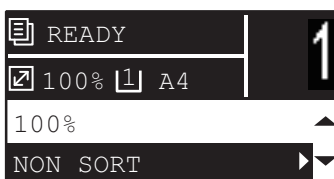

Menu Functions	Settings
FINISHING	NON SORT
	SORT
	ROTATE SORT

- 1 Press [COPY].
- 2 Press  $\nabla$  or  $\triangle$  to select the item displayed on the LCD screen, and then press  $\triangleright$ .
- 3 Press  $\nabla$  or  $\triangle$  to select the setting item, and then press [OK].
- 4 Specify the number of copies to “2” or more.  
 P.35 “Copying originals”

**When placing the original on the original glass**

After the first original is scanned, the LCD screen shows “NEXT ORIGINAL?”.

Make sure that “SCAN NEXT PAGE” is selected, place the next original on the original glass, and then press [OK] or [START]. When all the originals have been scanned, select “FINISHED”, and then press [OK] or [START].

Note

“CANCEL JOB?” is displayed if there is no operation for a certain period.

## ■ Copying two or four pages on each sheet

You can copy two or four original pages on each sheet of paper.

**OFF:** Disables this function.

**2IN1:** Copies two pages on a sheet of paper.

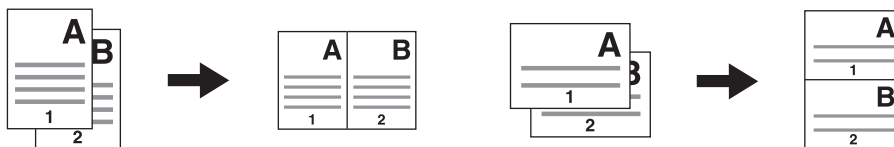

**4IN1:** Copies four pages on a sheet of paper.

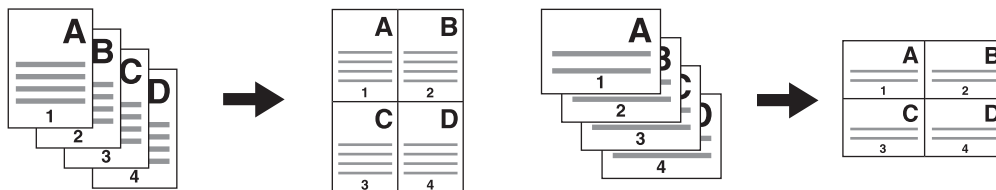

### Note

- Be sure the [Paper size], [EXPOSURE] and the like are set before selecting [2IN1/4IN1].
- You need to make settings to use the “2IN1/4IN1” function from “USER FUNCTIONS” - “COPY” - “2IN1/4IN1”.  
[P.172](#) “User functions menu items”
- This function is not available for some paper sizes. If you have set the unavailable sizes, the LCD screen shows the error message and you cannot use this function.  
[P.20](#) “Preparation 2 - Loading Paper”  
[P.32](#) “Preparation 3 - Registering Paper Size and Type”
- Copying without specifying paper size and direction of the original pages may result in unexpected page allocation order or image position.
- When a 2-sided original is placed with its top on the left of the Reversing Automatic Document Feeder in 2in1/4in1 copying, set [IMAGE DIRECTION] to “OFF”.



Menu Functions	Settings
2IN1/4IN1	OFF
	2IN1
	4IN1

- 1 Press [COPY].
- 2 Press  $\nabla$  or  $\triangle$  to select the item displayed on the LCD screen, and then press  $\triangleright$ .
- 3 Press  $\nabla$  or  $\triangle$  to select the setting item, and then press  $\triangleright$ .

---

## 4 Follow the instructions on the LCD screen to use the “2IN1/4IN1” function. You are instructed to make the following settings.

- **ORIGINAL SIZE**

Press ▾ or ▴ to select the size of the original.

- **ORIGINAL ORIENTATION**

Press ▷ or ◁ to select the portrait or landscape orientation of the original.

- **SET ORIGINAL**

Place the originals as shown on the LCD screen. Make sure that you place the original in the same orientation as the one selected in “ORIG. ORIENTATION”.

- **NEXT ORIGINAL?**

When you place the original on the original glass, this message appears. Press ▾ or ▴ to select “SCAN NEXT PAGE”. Select “FINISHED” when you have finished scanning your originals.

### Note

- The size of the original selected in [ORIGINAL SIZE] is disabled if it is detected automatically. For the detectable original sizes, see the following page:  
 P.34 “Acceptable originals”
- If the size of the original is not detected automatically, specify [ORIGINAL SIZE] and place the original on the original glass.
- “CANCEL JOB?” is displayed if there is no operation for a certain period.

## ■ Copying both sides of a card on a sheet

You can copy the front and back of a card on a sheet of paper.

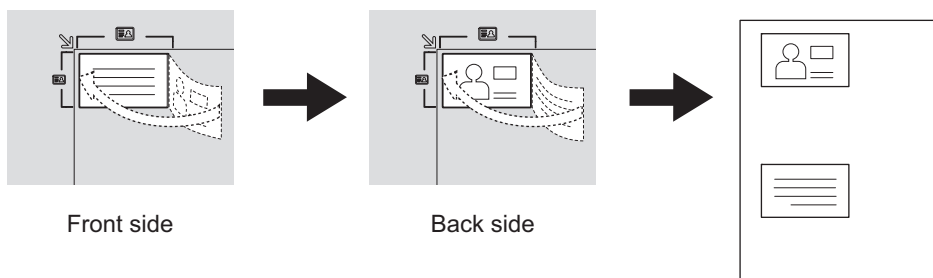

**Tip**

You can directly enable this function by pressing  $\triangleright$ . The button operation varies depending on the region.  
For regions other than Europe and the Americas:

P.38 “Using the “EXPOSURE” or “ID CARD” function quickly”

**Note**

- Be sure to set the paper size and density, etc. before selecting [ID CARD].
- The settings for the area to scan originals and the print position vary from region to region, so that the area wider than the card frame of the original glass might be scanned depending on the region.
- The upper and left areas (about 4 mm in width) cannot be copied. To copy up to the edges of a card, place the card apart from the edges of the original glass.



Menu Functions	Settings
ID CARD	OFF
	ON

- 1** Press [COPY].
- 2** Press  $\nabla$  or  $\triangle$  to select the item displayed on the LCD screen, and then press  $\triangleright$ .
- 3** Press  $\nabla$  or  $\triangle$  to select the setting item, and then press [OK].

---

**4 Follow the instructions on the LCD screen to use the “ON” function. You are instructed to make the following settings.**

- **SET FRONT OF ID CARD**

Place the front of a card face down at the upper left on the original glass, and then press [START].

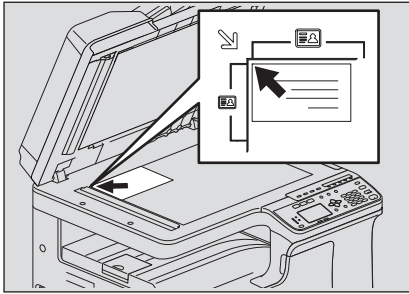

- **SET BACK OF ID CARD**

Turn over the card and place the back surface face down on the original glass, and then press [START].

**Note**

“CANCEL JOB?” is displayed if there is no operation for a certain period.

## Erasing the shadow on edges

You can erase the shadow on the edges of copies. When you copy thick books, you can erase the surrounding shadow with this function. The area to erase can be changed from 4 to 15 mm (0.2 to 0.6") in increments of 1 mm (0.04").

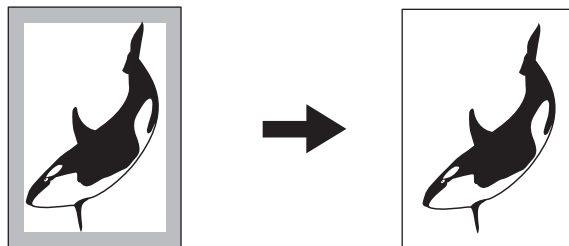

**Tip**

- This function is available only for paper of standard sizes.
- If the original is different from paper in size (the ratios of width and height are different), the shadow might not be erased on some edges.

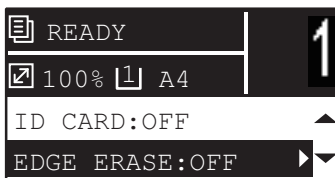

Menu Functions	Settings
EDGE ERASE	OFF
	ON

- 1 Press [COPY].
- 2 Press  $\nabla$  or  $\triangle$  to select the item displayed on the LCD screen, and then press  $\triangleright$ .
- 3 Press  $\nabla$  or  $\triangle$  to select the setting item.
- 4 Set the setting as follows.
  - For "OFF"  
Press [OK].
  - For "ON"
    1. Press  $\triangleright$ .
    2. Press  $\triangleright$  or  $\triangleleft$  to increase or decrease the value for the area to erase.
    3. Press [OK].

**Tip**

If you just press [OK] for "ON", the default value (7 mm (0.3")) of this function is used.

## ■ Copying right and left pages separately

When you place a booklet-type original on the original glass while it is being opened, the right and left pages of the opened section can be copied separately on different paper. Also, they can be copied on both sides of paper. You do not need to move the original on the original glass. The book margin width can be set between 8 to 30 mm (0.3 to 1.2") in increments of 1 mm (0.04").

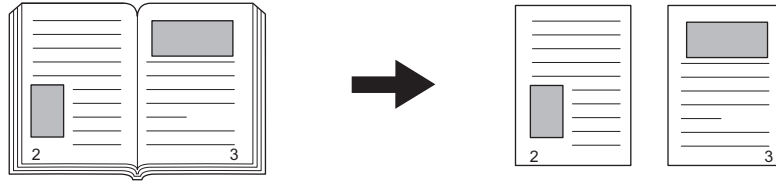

### Note

A4, B5, LT, and 16K sizes are available for this function.

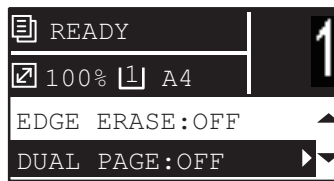

Menu Functions	Settings
DUAL PAGE	OFF
	ON

- 1** Press [COPY].
- 2** Press  $\nabla$  or  $\triangle$  to select the item displayed on the LCD screen, and then press  $\triangleright$ .
- 3** Press  $\nabla$  or  $\triangle$  to select the setting item.
- 4** Set the setting as follows.
  - For "OFF"  
Press [OK].
  - For "ON"
    1. Press  $\triangleright$ .
    2. Press  $\triangleright$  or  $\triangleleft$  to increase or decrease the value for the book margin width.
    3. Press [OK].

### Tip

If you just press [OK] for "ON", the default value (15 mm (0.6")) of this function is used.



## Shifting the pages to the right or left

You can shift pages to the right or left. The shifted area can be used as a margin for punching holes or stapling. The margin can be changed from 4 to 15 mm (0.2 to 0.6") in increments of 1 mm (0.04").

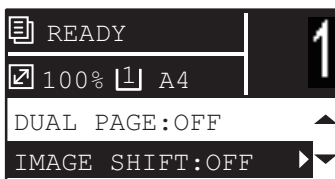
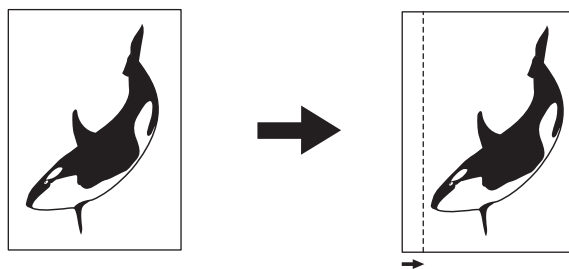

Menu Functions	Settings
IMAGE SHIFT	OFF
	LEFT MARGIN
	RIGHT MARGIN

- 1** Press [COPY].
- 2** Press  $\nabla$  or  $\triangle$  to select the item displayed on the LCD screen, and then press  $\triangleright$ .
- 3** Press  $\nabla$  or  $\triangle$  to select the setting item.
- 4** Set the setting as follows.
  - For "OFF"  
Press [OK].
  - For "LEFT MARGIN" or "RIGHT MARGIN":
    1. Press  $\triangleright$ .
    2. Press  $\triangleright$  or  $\triangleleft$  to increase or decrease the value for the margin.
    3. Press [OK].

**Tip**

If you just press [OK] for "ON", the default value (7 mm (0.3")) of this function is used.

## ■ Copying on one or both sides

You can select whether originals and paper are 1-sided or 2-sided individually. You can make copies of 1-sided originals into the both sides of paper so that you can save paper.

**1 > 1 SIMPLEX** (📖 P.59 “Copying on one side”)

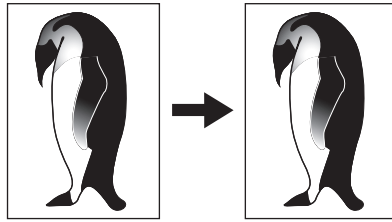

**1 > 2 DUPLEX** (📖 P.60 “Copying on both sides”)

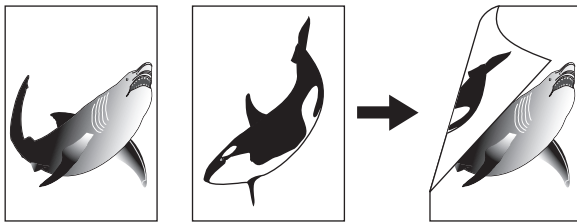

**2 > 2 DUPLEX** (📖 P.60 “Copying on both sides”)

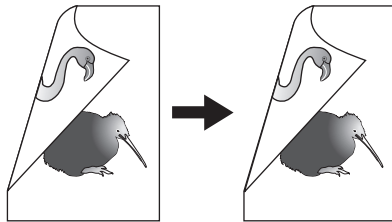

**2 > 1 SPLIT** (📖 P.59 “Copying on one side”)

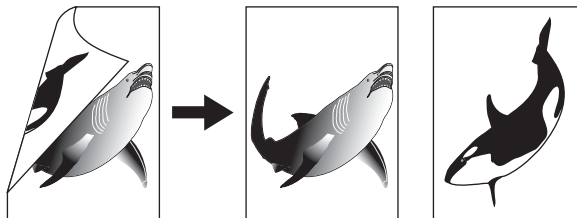

### Note

To scan 2-sided originals automatically, the Reversing Automatic Document Feeder is required.

## ❑ Copying on one side

You can copy 1-sided or 2-sided originals on the one side of paper.

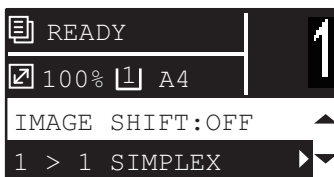

Menu Functions	Settings	Description
2-SIDED	1 > 1 SIMPLEX	1-sided original -> 1-sided copy.
	1 > 2 DUPLEX	1-sided original -> 2-sided copy. (📖 P.60)
	2 > 2 DUPLEX	2-sided original -> 2-sided copy. (📖 P.60)
	2 > 1 SPLIT	2-sided original -> 1-sided copy.

- 1** Press [COPY].
- 2** Press ▾ or ▲ to select the item displayed on the LCD screen, and then press ▶.
- 3** Press ▾ or ▲ to select the item for copying on one side, and then press [OK].

### When placing the original on the original glass

After the first original is scanned, the LCD screen shows “NEXT ORIGINAL?”.

Make sure that “SCAN NEXT PAGE” is selected, place the next original on the original glass, and then press [OK] or [START]. When all the originals have been scanned, select “FINISHED”, and then press [OK] or [START].

#### Note

“CANCEL JOB?” is displayed if there is no operation for a certain period.

## ❑ Copying on both sides

You can copy 1-sided or 2-sided originals on the both side of paper.

### Note

For double-sided printing, use plain paper (64 to 80g/m<sup>2</sup>).

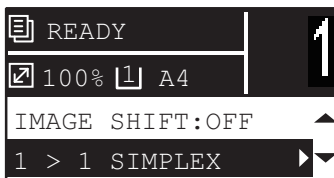

Menu Functions	Settings	Description
2-SIDED	1 > 1 SIMPLEX	1-sided original -> 1-sided copy. (📖 P.59)
	1 > 2 DUPLEX	1-sided original -> 2-sided copy.
	2 > 2 DUPLEX	2-sided original -> 2-sided copy.
	2 > 1 SPLIT	2-sided original -> 1-sided copy. (📖 P.59)

- 1 Press [COPY].
- 2 Press ▾ or ▲ to select the item displayed on the LCD screen, and then press ▷.
- 3 Press ▾ or ▲ to select the item for copying on both sides, and then press ▷.
- 4 Press ▾ or ▲ to select the finishing mode, and then press [OK]. Select “BOOK” for “open to left”, or “TABLET” for “open to top”.

### When placing the original on the original glass

After the first original is scanned, the LCD screen shows “NEXT ORIGINAL?”.

Make sure that “SCAN NEXT PAGE” is selected, place the next original on the original glass, and then press [OK] or [START]. When all the originals have been scanned, select “FINISHED”, and then press [OK] or [START].

### Note

“CANCEL JOB?” is displayed if there is no operation for a certain period.

## ■ Adding a page number and date/time on the copied paper

You can add a page number and date/time on the copied paper.

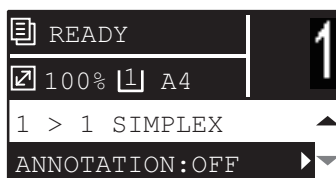
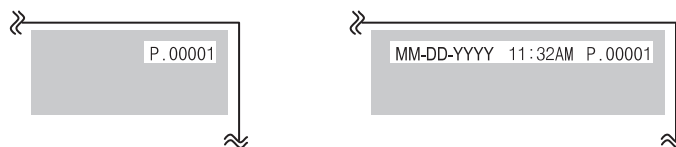

Menu Functions	Settings
ANNOTATION	OFF
	PAGE NO.
	PAGE No.+DATE/TIME

- 1 Press [COPY].
- 2 Press  $\nabla$  or  $\triangle$  to select the item displayed on the LCD screen, and then press  $\triangleright$ .
- 3 Press  $\nabla$  or  $\triangle$  to select the setting item, and then press [OK].

## ■ Removing blank pages

You can skip blank pages in the original when copying.

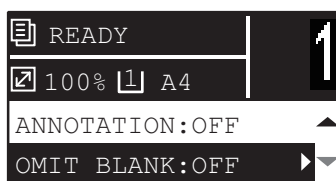
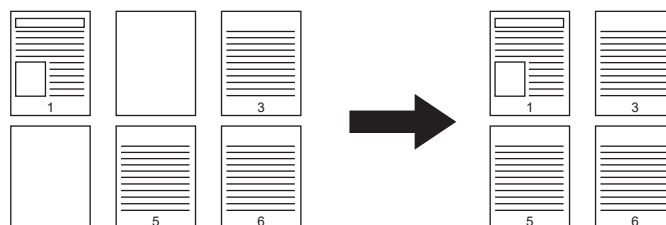

Menu Functions	Settings
OMIT BLANK PAGE	OFF
	ON

- 1 Press [COPY].
- 2 Press  $\nabla$  or  $\triangle$  to select the item displayed on the LCD screen, and then press  $\triangleright$ .
- 3 Press  $\nabla$  or  $\triangle$  to select the setting item, and then press [OK].

## ■ Copying different sizes in one go

When different sizes of originals are mixed and placed on the Reversing Automatic Document Feeder, some combinations of sizes can be copied in one go.

The combination of the original sizes that can be mixed are as follows:

Other than North America: A3 and A4 or B4 and B5

North America: LD and LT or LG and LT-R

### Note

When this function sets to “ON”, the equipment is switched to the automatic paper selection mode. In the automatic paper selection mode, a copy is made on copy paper of the same size as the original. Place paper whose sizes are the same as those of the originals in the corresponding drawers in advance.



Menu Functions	Settings
MIXED SIZE	OFF
ORIGINAL	ON

- 1** Press [COPY].
- 2** Press  $\nabla$  or  $\triangle$  to select the item displayed on the LCD screen, and then press  $\triangleright$ .
- 3** Press  $\nabla$  or  $\triangle$  to select the setting item, and then press [OK].

## Image direction

When you make 1-sided portrait originals to 2-sided copy by placing them in a landscape direction, normally the copied pages are “open to top”. With this function you can make them “open to left”. This function is called “image direction”.

When you make 2-sided “open to left” portrait originals to 1-sided copy, normally the copied pages exit in a different direction alternately. With this function, you can make them all exit in the same direction.

### 1-sided portrait original (placed in a landscape direction) -> 2-sided copy

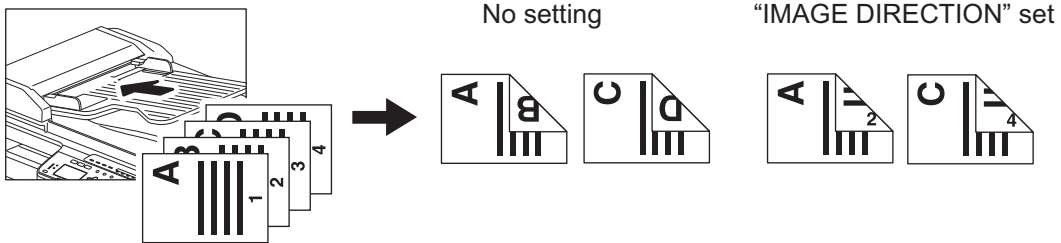

### 2-sided “open to left” portrait original -> 1-sided copy

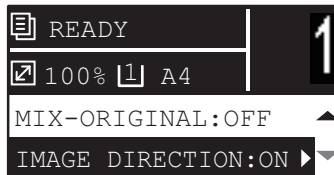
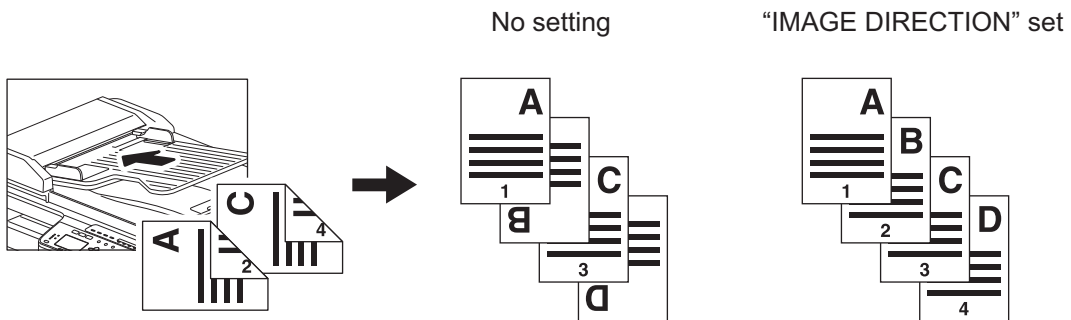

Menu Functions	Settings
IMAGE DIRECTION	OFF
	ON

- 1 Press [COPY].
- 2 Press  $\nabla$  or  $\triangle$  to select the item displayed on the LCD screen, and then press  $\triangleright$ .
- 3 Press  $\nabla$  or  $\triangle$  to select the setting item, and then press [OK] or  $\triangleright$ .

## ■ Continuing the scanning for a copy

When you copy with the Reversing Automatic Document Feeder (RADF), you can select whether you continue scanning the next originals after the last loaded original is scanned.

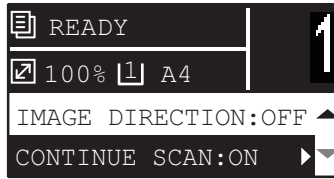

Menu Functions	Settings
CONTINUE SCAN	OFF
	ON

- 1** Press [COPY].
- 2** Press  $\nabla$  or  $\triangle$  to select the item displayed on the LCD screen, and then press  $\triangleright$ .
- 3** Press  $\nabla$  or  $\triangle$  to select the setting item, and then press [OK].



## Using Templates (Copy)

Once you have set the several functions and settings, you can register up to three of them as “templates” and recall one of them for frequent use.

### ■ Registering the templates

- 1 Make settings for the functions to register as a template.
- 2 Press [TEMPLATE].

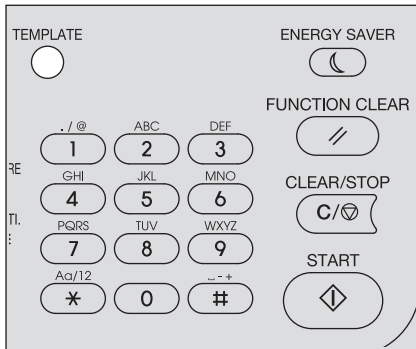

- 3 Press  $\nabla$  or  $\triangle$  to select “REGISTRATION”, and then press  $\triangleright$ .

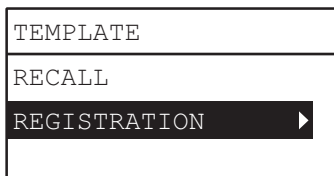

- 4 Press  $\nabla$  or  $\triangle$  to select a template, and then press [OK].

#### Note

- You can register three templates for copying.
- The settings are overwritten if you select an existing template.
- You can also register and edit templates with TopAccess. For details, refer to the **TopAccess Guide**.

You can specify the following items in copy templates.

No.	Item Name	Settings
1	Copy Quantity	1-999
2	Exposure	AUTO, MANUAL( $\pm 4$ )
3	Original Mode	TEXT/PHOTO, TEXT, PHOTO, BACKGROUND ERASE
4	Paper Source	Drawer 1~4, Bypass, APS
5	Zoom	25~400%, AMS
6	Finishing	NON SORT, SORT, ROTATE SORT
7	Nin1	OFF, 2IN1, 4IN1
8	Nin1-Original size	
9	Nin1-Original orientation	PORT., LAND.
10	ID Card	OFF, ON
11	Edge Erase	OFF, ON
12	Edge Erase Adjustment	4~15
13	Dual Page	OFF, ON
14	Dual Page Adjustment	8~30
15	Image Shift	OFF, LEFT, RIGHT
16	Image Shift Adjustment	4~15
17	2-Sided	1>1 SIMPLEX, 1>2 DUPLEX, 2>2 DUPLEX, 2>1 SPLIT

No.	Item Name	Settings
18	2-Sided	BOOK, TABLET
19	Annotation	OFF, PAGE NO., PAGENO.+DATE/TIME
20	Omit Blank Page	OFF, ON
21	Mixed Size Original	OFF, ON
22	Image Direction	OFF, ON
23	Continue Scan*	OFF, ON

\* This item is available only when the Reversing Automatic Document Feeder (RADF) is installed.

## ■ Recalling a template

- 1** Press [TEMPLATE].
- 2** Press ▾ or ▲ to select “RECALL”, and then press ▷.

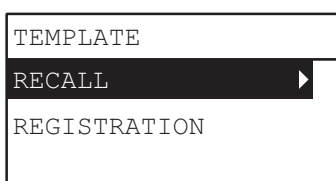

- 3** Press ▾ or ▲ to select a template, and then press [OK].

## PRINT FUNCTIONS (Windows)

<b>Before Using the Printer Driver</b> .....	<b>68</b>
Configuring the options .....	68
Setting the department code .....	71
<b>Printing From Application</b> .....	<b>73</b>
Considerations and limitations .....	73
How to print .....	73
<b>Status Monitor</b> .....	<b>75</b>
Monitoring the print status and reporting print errors .....	75
<b>Setting up Print Options</b> .....	<b>76</b>
How to set up .....	76
Print options .....	79
<b>Printing With Best Functions for Your Needs</b> .....	<b>95</b>
Layout and finishing options in [Basic] tab menu .....	95
Layout and finishing options in [Finishing] tab menu .....	96
Finishing options in [Effect] tab menu .....	99

## Before Using the Printer Driver

Before printing, you have to configure the following options:

- Configuration Settings  
To use devices installed in this equipment, you must first configure their options on the [Configuration] tab of the printer driver.  
 P.68 “Configuring the options”
- Department Code  
This equipment can manage jobs by department codes. This feature allows you to manage job counters for each department code. For example, a network administrator can check the number of copies printed by a specific department.  
If the department code function is enabled, enter your department code provided by your administrator.

### ■ Configuring the options

To use this equipment properly, you need to save the configuration of the options installed on the [Configuration] tab menu after you installed the printer drivers. In the default setting, you can obtain the configuration data of options installed automatically by opening the [Configuration] tab menu. If SNMP communication between this equipment and your computer is not available, or you want to configure options manually, see the following page:  
 P.68 “Configuring options manually”

#### Tip

When SNMP communication between this equipment and your computer is enabled, you can retrieve the option configuration information by clicking [Update Now].

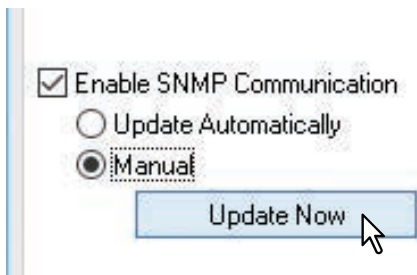

### □ Configuring options manually

If SNMP communication between this equipment and your computer is not available:

#### Setting the [Configuration] tab manually

##### Note

You need to log in to Windows with the “Administrator” privilege.

#### 1 Open the printers folder.

Click [Start] and select [Settings] > [Devices] > [Devices and Printers].

##### Tip

- For Windows 8.1 / Windows Server 2012 or later, right-click in the lower left of the screen, then click [Control Panel] > [Devices and Printers].
- For Windows 7, click [Start] > [Devices and Printers].
- For Windows Server 2008, click [Start] > [Control Panel] > [Hardware and Sound] > [Printers].

## 2 Right-click the printer driver of this equipment and select [Printer properties] from the displayed menu.

The printer driver properties dialog box appears.

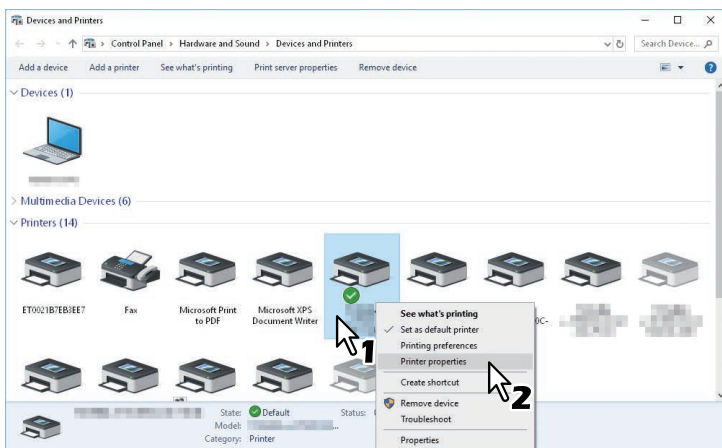

### Tip

- For Windows Server 2008, select the printer driver for this equipment, and then click [Printer properties] in the [File] menu.
- If the [File] menu is not displayed, press [Alt].

## 3 Select the [Configuration] tab menu, and set the following options.

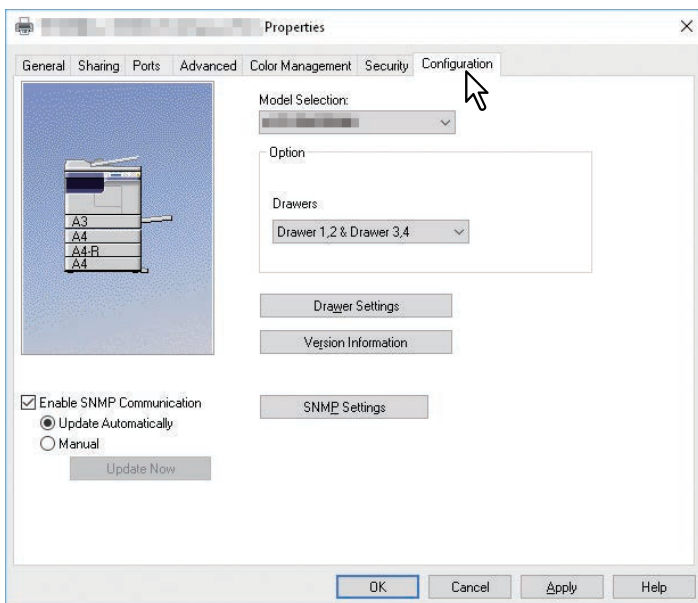

**Model Selection** — Select the model name.

**Option - Drawers** — Select the drawer configuration.

### Tip

For more information about each item, see the descriptions about the Configuration tab.

P.93 “[Configuration] tab”

## 4 Click [Drawer Settings].

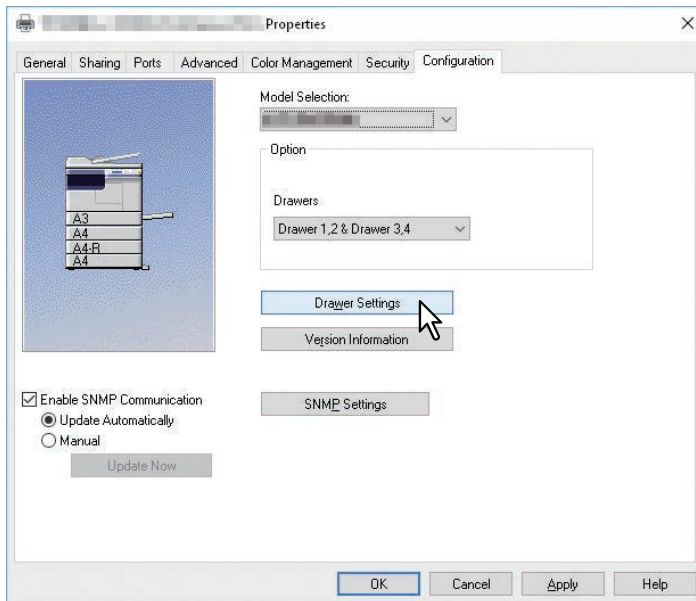

The [Drawer Settings] dialog box appears.

## 5 Set the following options and click [OK].

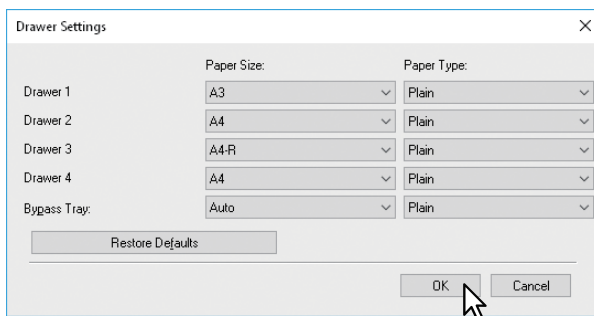

**Drawer 1** — Select the size of paper that is loaded in the Drawer 1. The paper type for the drawer is fixed to [Plain].

**Drawer 2** — Select the size of paper that is loaded in the Drawer 2. The paper type for the drawer is fixed to [Plain].

**Drawer 3** — Select the size of paper that is loaded in the Drawer 3. The paper type for the drawer is fixed to [Plain].

**Drawer 4** — Select the size of paper that is loaded in the Drawer 4. The paper type for the drawer is fixed to [Plain].

**Bypass Tray** — Select the size and type of paper that is loaded in the Bypass Tray.

### Tip

- Setup items differ depending on the model and the option configuration.
- For more information about each item, see the descriptions about the Drawer Settings.  
📖 P.94 “Drawer Settings”

## 6 Click [Apply] or [OK] to save settings.

## ■ Setting the department code

When the department code function is enabled on this equipment, you have to enter your department code to send a print job via the printer driver.

This allows a network administrator to check the number of copies printed by specific department.

Ask your administrator whether you have to enter the department code. If you have to, obtain the department code you need to enter.

If the department code is required, you can enter the department code into the [Department Code] box of the printer as described below to save you having to enter the department code each time you print.

### Note

If printing is performed with an incorrect department code, a dialog box indicating that it is incorrect appears. In this case, enter the correct one or stop transmitting. If the SNMP setting of this equipment is disabled or printing is performed from an XPS printer driver, this dialog box will not appear, and the job becomes invalid and is deleted. An error report is then printed out from this equipment.

### Tip

A department code can be entered every time you begin printing. If you have to use a different department code for each print job, enter it when you begin printing.

## □ Entering department code

### 1 Open the printers folder.

Click [Start] and select [Settings] > [Devices] > [Devices and Printers].

### Tip

- For Windows 8.1 / Windows Server 2012 or later, right-click in the lower left of the screen, then click [Control Panel] > [Devices and Printers].
- For Windows 7, click [Start] > [Devices and Printers].
- For Windows Server 2008, click [Start] > [Control Panel] > [Hardware and Sound] > [Printers].

### 2 Right-click the printer driver of this equipment and select [Printing Preferences] from the displayed menu.

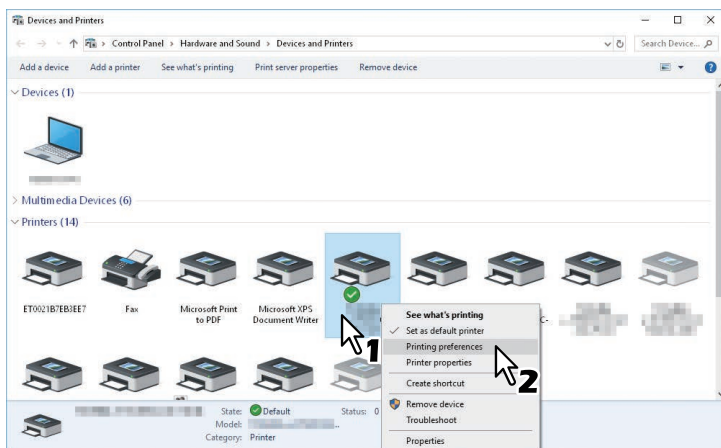

### Tip

- For Windows Server 2008, select the printer driver for this equipment, and then click [Printer properties] in the [File] menu.
- If the [File] menu is not displayed, press [Alt].

**3 Display the [Others] tab menu and enter your department code in the [Department Code] box.**

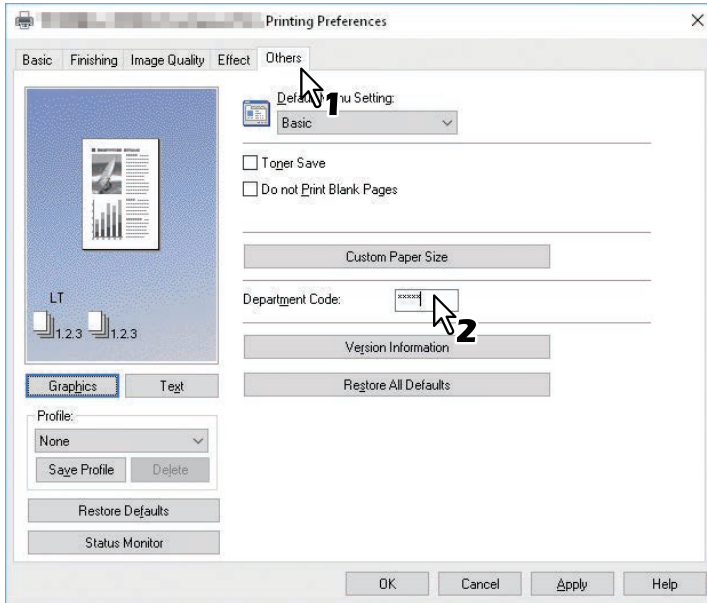

The department code is a 5-digit number.

**4 Click [Apply] or [OK] to save the settings.**



## Printing From Application

This section describes how to print a document from application.

📖 P.73 “Considerations and limitations”

📖 P.73 “How to print”

### ■ Considerations and limitations

- Some print options can be set from both the application and the printer driver, such as collation. If the collation is set from the application, documents may not be properly printed. If that happens, use the printer driver to set the collation. Depending on the application, some print options such as the orientation need to be set from the application. For print options that can be set from both the application and the driver, refer to the manual of the application.
- Some print options are not displayed on the screen of printer driver depending on the model or type of printer driver.
- When printing is carried out from Adobe Acrobat Reader/Acrobat by using a PS driver, its [Print Paper Size] setting, [Manual Scale] setting and [Booklet] setting are disabled. To carry out printing by using them, select the [Print As Image] check box in the print setting of Adobe Acrobat Reader/Acrobat. Or, carry out printing by means of the functions embedded in Adobe Acrobat Reader/Acrobat.

### ■ How to print

Once you have installed the printer driver and configured it properly, you can print directly from most Windows applications. Simply choose the Print command from your application.

You can print using the various functions by setting print options on the printer driver.

#### Printing from Windows applications

The following describes an example for printing from Notepad on Windows 10.

#### 1 Open a file and select [Print] from the application’s [File] menu.

The [Print] dialog box appears.

#### 2 Select your printer, and then click [Preferences].

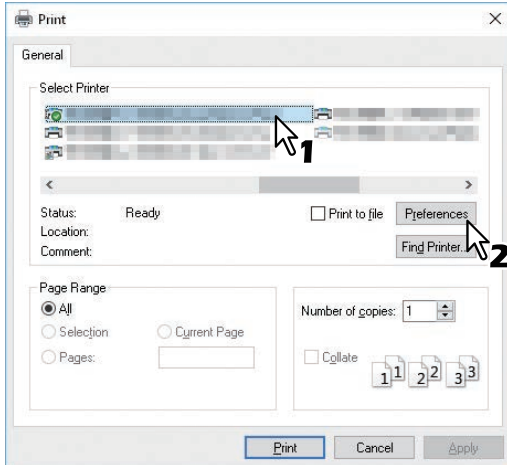

The printing preferences dialog box appears.

#### Tip

The procedures for displaying the properties dialog for the printer driver may be different depending on the application that you are using. See your application’s manual about displaying the printer properties dialog box.

### 3 Set the print options on each tab according to how you want to print.

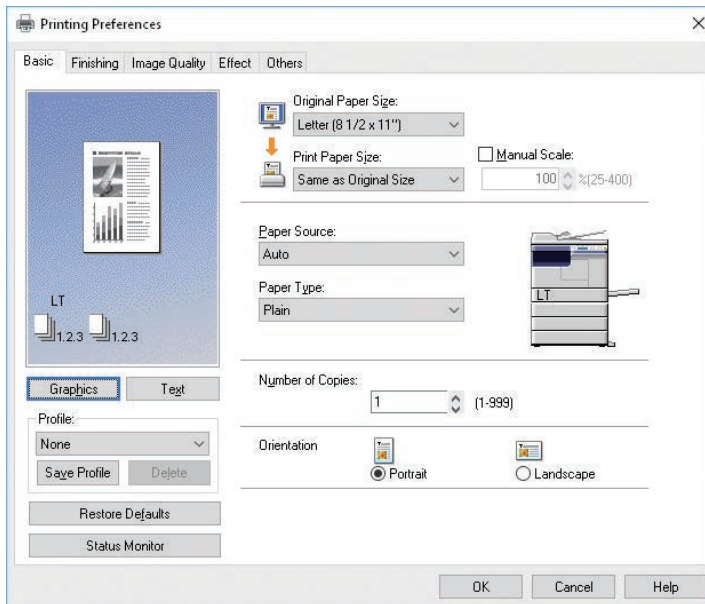

Setting the print options varies depending on how you want to print a document.

P.79 "Print options"

### 4 Click [OK] to save the settings.

### 5 Click [Print] to print a document.

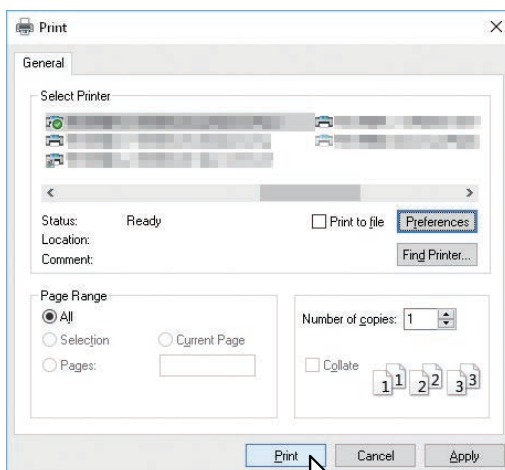

## Status Monitor

The status monitor is utility software that is installed with the printer driver. It can monitor the current print job and the current status of the equipment.



 P.75 “Monitoring the print status and reporting print errors”

### ■ Monitoring the print status and reporting print errors

You can start the status monitor from the [Status Monitor] button on the printer driver screen. When started, the status monitor icon appears in the notification area of the Windows taskbar.



The icon changes according to the status of the equipment.

-  is a “Ready” icon that indicates the equipment is ready to print.
-  is a “Warning” icon that prompts you to take action as soon as possible.
-  is an “Error” icon that prompts you to take a troubleshooting action soon.  
If any error occurs, the LCD screen also shows the error message.

You can double-click the icon, or right-click it and select “Start” to open the status monitor dialog and see the detailed information.

#### Tip

If you right-click the icon and select “Exit”, the status monitor terminates the operation.

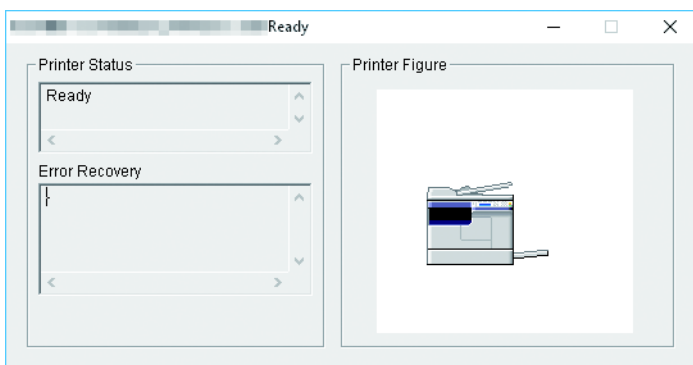

## Setting up Print Options

---

Print Options are the attributes you set to define the way a print job is processed.

📖 P.76 “How to set up”

📖 P.79 “Print options”

### Tip

To find the printing instructions for your specific needs, see the procedures in the following section.

📖 P.95 “Printing With Best Functions for Your Needs”

## ■ How to set up

There are several ways to set print options. How the settings affect printing varies depending on the way you set the options. The tabs displayed also vary depending on how you display the printer properties.

📖 P.76 “Setting initial values of print options”

📖 P.76 “Setting print options for each print job”

📖 P.77 “Setting print options using profiles”

### □ Setting initial values of print options

Setting the print options by displaying the printer properties from the Printers folder within the Windows Start menu will establish the initial values of the options. For example, the paper size setting you most commonly use, etc., are settings you will not want to change every time you print. It is convenient to set these options as initial values.

#### How to display:

#### 1 Open the printers folder.

Click [Start] and select [Settings] > [Devices] > [Devices and Printers].

#### Tip

- For Windows 8.1 / Windows Server 2012 or later, right-click in the lower left of the screen, then click [Control Panel] > [Devices and Printers].
- For Windows 7, click [Start] > [Devices and Printers].
- For Windows Server 2008, click [Start] > [Control Panel] > [Hardware and Sound] > [Printers].

#### 2 Select your printer, and then click [Printing preferences] in the [File] menu.

### □ Setting print options for each print job

The print options that are set in properties dialog box, which can be accessed from the [Print] dialog box of the application, are only applied to the current print job, so once you close the application, the options will be invalid.

#### How to display:

#### 1 Click the [File] menu and select [Print] on application.

#### 2 Select your printer, and then click [Preferences].

## ❑ Setting print options using profiles

Using profiles, you can save the print settings or apply the saved settings to a print job.

In order to print a document using profiles, you must first create the saved profile.

📖 P.77 “Saving profile”

Once you save a profile, you can apply its settings to a print job.

📖 P.78 “Loading profile”

You can also delete unnecessary profiles.

📖 P.78 “Deleting profile”

### Saving profile

You can register up to 20 profiles for each printer driver.

#### 1 Configure the print options on each tab.

Setting the print options varies depending on how you want to print a document.

📖 P.79 “Print options”

#### 2 Click [Save Profile] in the Profile group.

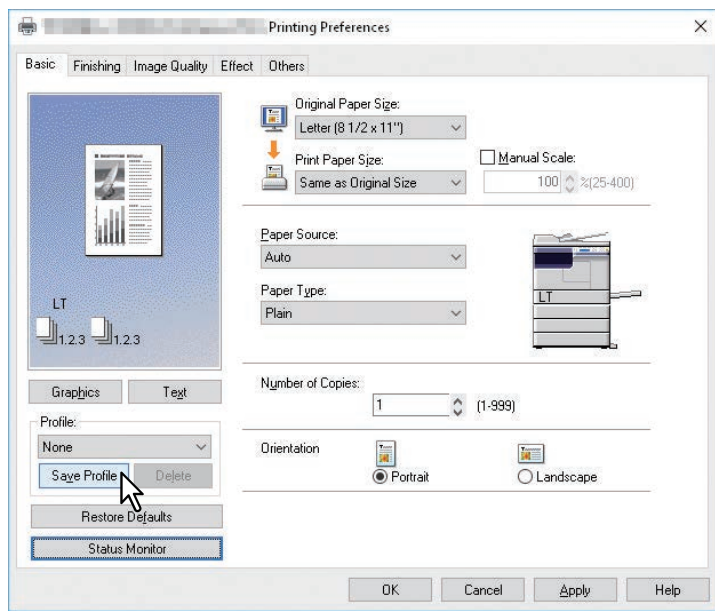

The [Profile Name] dialog box appears.

#### 3 Enter the profile name and click [OK].

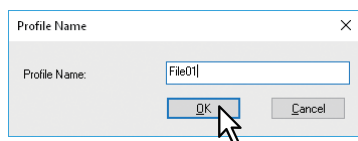

The file name must be up to 63 characters long.

#### Tip

- If you enter an existing profile name, you are prompted to confirm whether you want to overwrite it. If you want, click [OK].
- If you try to save more than 20 profiles, a dialog box notifying you that no more can be saved appears, then the 21st profile is saved as a temporary profile. If you want to register this temporary profile, delete unnecessary profiles first, and then select [Temporary Profile] to recall this profile and click [Save Profile] to save it.
- You cannot specify [None] for the profile name.

#### 4 The profile is saved.

## Loading profile

### 1 Select a profile in the [Profile] box.

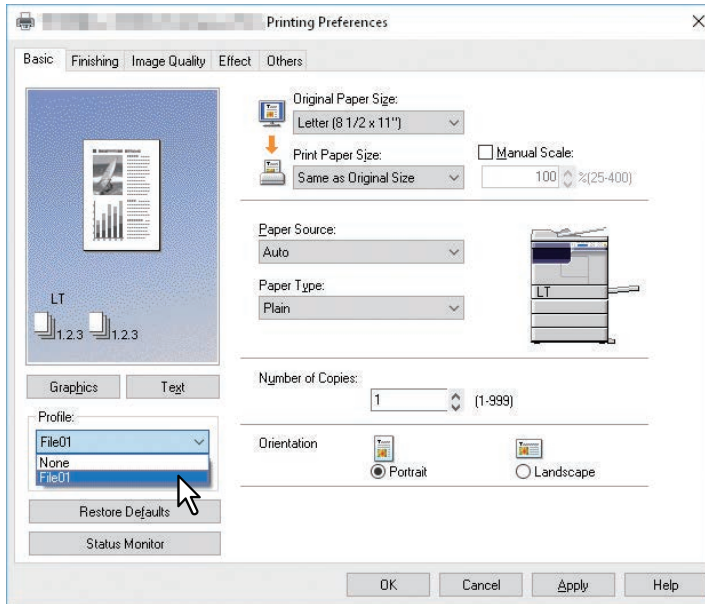

The setting options in the profile are reflected on each tab.

#### Note

To restore the default settings after you select the profile, click [Restore Defaults] on each tab. Selecting [None] on the [Profile] box will not restore them.

## Deleting profile

### 1 Select the profile that you want to delete in the [Profile] box, and click [Delete].

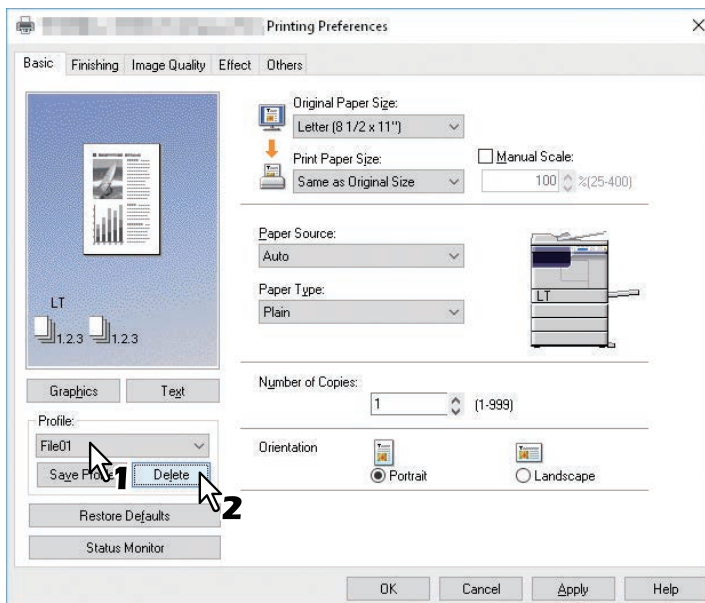

The [Confirm Delete] dialog box appears.

### 2 Click [Yes] to delete the selected profile.

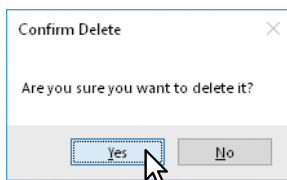

## ■ Print options

This section describes print options in each tab of the printer driver. This section will help you to find the description of specific print options, or understand their individual functions.

- 📖 P.79 “How to display:”
- 📖 P.81 “[Basic] tab”
- 📖 P.83 “[Finishing] tab”
- 📖 P.87 “[Image Quality] tab”
- 📖 P.88 “[Effect] tab”
- 📖 P.90 “[Others] tab”
- 📖 P.93 “[Configuration] tab”

**Tip**

The following tabs are the setting items which depend on the OS. For their setting procedures and details, refer to the Operator’s Manual or the Help of the OS to be used.

- [General] tab
- [Sharing] tab
- [Ports] tab
- [Advanced] tab
- [Color Management] tab
- [Security] tab

### ❑ How to display:

#### 1 Open the printers folder.

Click [Start] and select [Settings] > [Devices] > [Devices and Printers].

**Tip**

- For Windows 8.1 / Windows Server 2012 or later, right-click in the lower left of the screen, then click [Control Panel] > [Devices and Printers].
- For Windows 7, click [Start] > [Devices and Printers].
- For Windows Server 2008, click [Start] > [Control Panel] > [Hardware and Sound] > [Printers].

#### 2 Select your printer, and then click [Printing preferences] in the [File] menu.

- If the [File] menu is not displayed, press [Alt].
- The printing preferences dialog box appears.

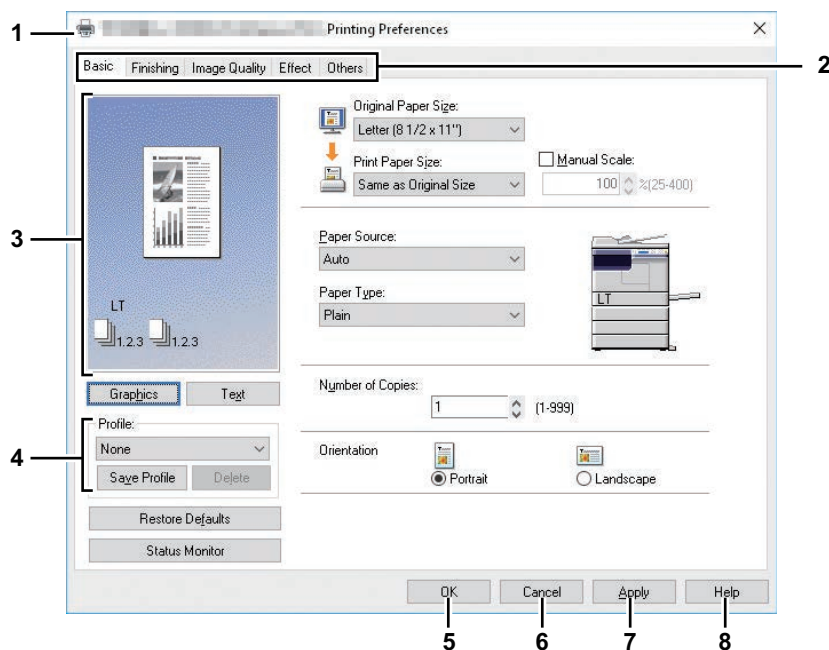

---

## 1. Printer Name

Displays the name given to the printer driver when it was installed, or the name it displays on the icon in the Printer folder.

## 2. Menu Tabs

The menu items of the printer driver are displayed as tabs. Clicking on a tab will display the contents of the selected tab. The tabs displayed vary depending on the way the print properties are displayed.

### - [Basic] tab

Contains basic print operation settings, such as original paper size, print paper size, paper source, paper type, orientation, and so on.

 P.81 “[Basic] tab”

### - [Finishing] tab

Allows you to enable sort printing and N-up printing, and so on.

 P.83 “[Finishing] tab”

### - [Image Quality] tab

Allows you to select how images are printed.

 P.87 “[Image Quality] tab”

### - [Effect] tab

Contains print options that add the effects to your print jobs such as Watermarks, and so on.

 P.88 “[Effect] tab”

### - [Others] tab

Contains special features such as toner save, and so on.

 P.90 “[Others] tab”

### - [Configuration] tab

Allows you to configure the device options of the equipment. This tab is only displayed when the printer properties are accessed from the Printers folder.

 P.93 “[Configuration] tab”

## 3. Preview window

In the Preview window, you can preview how a document will be printed under the current settings of the printer driver. The image of a page to which the set print options are applied is displayed.

## 4. Profile

Print option settings can be saved as a profile file. You can save print option settings by clicking [Save Profile] and easily load a setting file by selecting a profile name in the box.

 P.77 “Setting print options using profiles”

## 5. [OK]

Enters the input settings and complete the print option settings.

## 6. [Cancel]

Cancel the input settings and exit the print option settings.

## 7. [Apply]

Enters the input settings without closing the print option settings. This button is only displayed when the printer properties are accessed from the Printers folder. This button remains grayed out until a setting is changed.

## 8. [Help]

Opens the Help for the printer driver.



## ❑ [Basic] tab

The [Basic] tab contains basic print operation settings, such as the original paper size, print paper size, paper source, paper type, orientation, and so on.

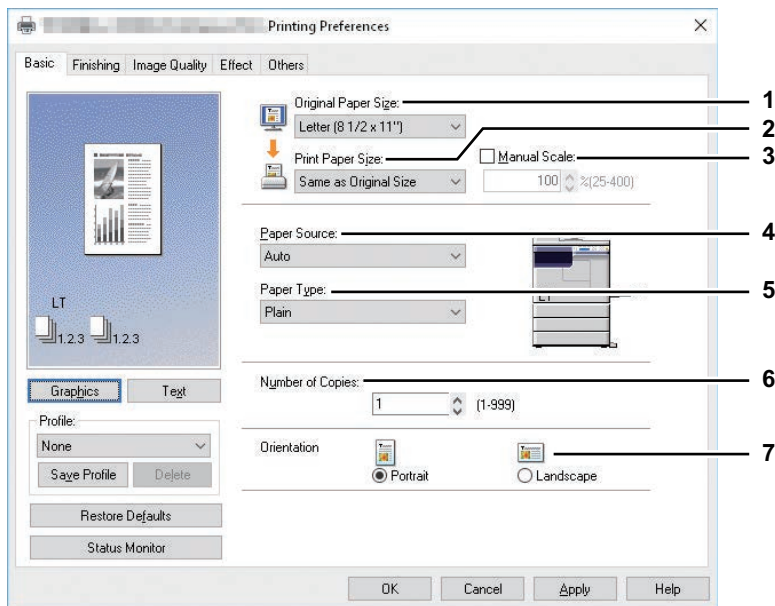

### 1. Original Paper Size

Selects the size of a document to be printed.  
Available original paper sizes are listed below:

- A4 (210 x 297 mm)
- A5 (148 x 210 mm)
- A3 (297 x 420 mm)
- B4 (257 x 364 mm)
- B5 (182 x 257 mm)
- Folio (210 x 330 mm)
- Letter (8 1/2 x 11")
- Legal (8 1/2 x 14")
- Ledger (11 x 17")
- Statement (5 1/2 x 8 1/2")
- Computer (10 1/8 x 14")
- 13"LG (8 1/2 x 13")
- 8.5"SQ (8 1/2 x 8 1/2")
- 16K (195 x 270 mm)
- 8K (270 x 390 mm)
- Env-Com10 (4 1/8 x 9 1/2")
- Env-Monarch (3 7/8 x 7 1/2")
- Envelope DL (110 x 220 mm)
- Envelope Cho-3 (120 x 235 mm)
- Envelope You-4 (105 x 235 mm)

#### Note

- The default paper size will be [A4] or [Letter] according to the regional setting in the Windows.
- Setup items differ depending on the model.

### 2. Print Paper Size

Selects the paper size to print. When you want to perform printing with the paper size which is same as that for the original, select [Same as Original Size].

---

### 3. Manual Scale

Enter the scale manually to enlarge or reduce an image. The ratio can be set at between 25 and 400%.

#### Note

If originals which include thin lines are printed when the zoom ratio is set, the line width may vary.

#### Tip

For detailed instructions on how to print with the [Manual Scale] setting, see the following page:

 P.95 “Fitting images within paper size”

### 4. Paper Source

Selects a paper source to print a job in the most suitable paper size. The figure on the right indicates the paper size set for each paper source. When you select a paper source, the chosen one is indicated with a green square in the figure.

- **Auto** — Automatically selects the paper set in this equipment according to the printed document size.
- **Drawer 1** — Paper is fed from the Drawer 1.
- **Drawer 2** — Paper is fed from the Drawer 2.
- **Drawer 3** — Paper is fed from the Drawer 3.
- **Drawer 4** — Paper is fed from the Drawer 4.
- **Bypass Tray** — Paper is fed from the Bypass Tray.

#### Note

The selectable values vary depending on the devices installed in this equipment and their configuration on the [Configuration] tab.

### 5. Paper Type

Sets the paper type.

- **Plain** — Printing on plain paper.
- **Thick** — Printing on thick paper.
- **Thick1** — Printing on thick 1 paper.
- **Thick2** — Printing on thick 2 paper.
- **Transparency** — Printing on transparent sheets.
- **Thin** — Printing on the back side of thin paper.

#### Note

- When [Drawer 1] to [Drawer 4] is selected in the [Paper Source] box, only [Plain] can be chosen in the [Paper Type] box.
- When [Envelope] is selected in the [Print Paper Size] box, [Envelope] will be displayed and you cannot change the paper type.

### 6. Number of Copies

Sets the number of printed copies. This can be set at between 1 and 999.

### 7. Orientation

Sets the paper printing direction.

- **Portrait** — The document is printed in the portrait direction.
- **Landscape** — The document is printed in the landscape direction.

## □ [Finishing] tab

The [Finishing] tab allows you to enable sort printing and N-up printing.

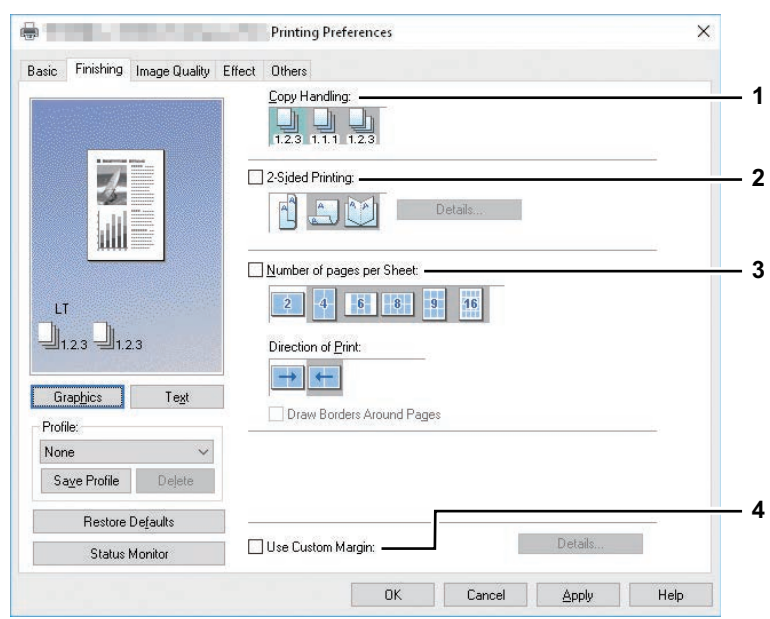

### 1. Copy Handling

Sets how to sort the printed sheets when more than one copy is made for printing.

- **Sort Copies** — Select this for sort-printing (1, 2, 3... 1, 2, 3...).

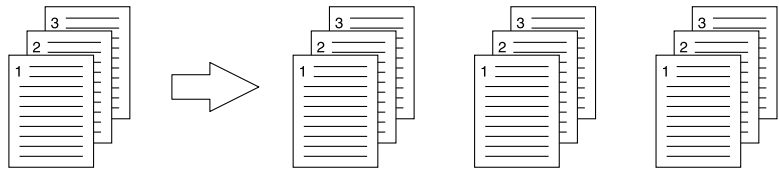

- **Group Copies** — Select this for group-printing (1, 1, 1... 2, 2, 2... 3, 3, 3...).



- **Rotated Sort Copies** — Select this for rotate sort-printing.

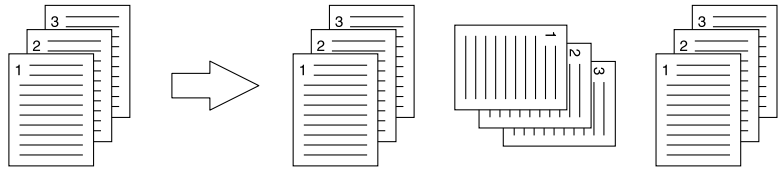

#### Note

- [Group Copies] and [Rotated Sort Copies] can be selected only when more than 1 copy is entered at the [Number of Copies] option.
- For rotated sort copies, you need to load paper of the same size in two paper sources (a drawer and the bypass tray) in advance, placing one in a landscape direction and another in a portrait direction. The paper size should be Letter, A4, B5, or 16K.

#### Tip

For the detailed instructions on how to print with the [Copy Handling] setting, see the following page:  
 P.96 “Sort printing”

## 2. 2-Sided Printing

This sets printing on both sides of paper. Select this check box and then the position of the margin for 2-sided printing.

- **Long Edge** — Select this to print on both sides of the paper with a margin on the long edge.

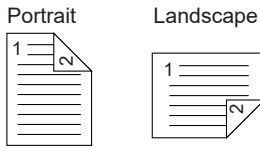

- **Short Edge** — Select this to print on both sides of the paper with a margin on the short edge.

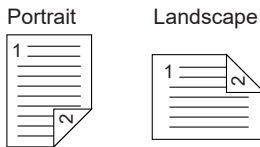

- **Booklet** — Select this to print a properly paginated booklet or magazine-style publication. When this is selected, click [Details] to specify the details of the Booklet printing.

 P.86 “Booklet Details”

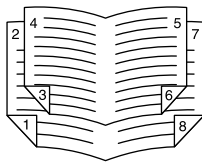

### Note

- Depending on the models, the 2-sided printing function is set to “ON” as a default.
- Be sure to select the following settings on the [Basic] tab to use this print option:
  - Any paper size other than envelopes from the [Print Paper Size] list. You cannot use envelopes.
  - [Plain] from the [Paper Type] list. You cannot use other paper types.

### Tip

For the detailed instructions on how to print with the [2-Sided Printing] setting, see the following page:

 P.97 “Printing on both sides of paper”

## 3. Number of pages per Sheet

Sets the printing of multiple pages on one sheet. The pages are reduced to fit the selected paper size automatically and printed.

- **2 pages** — Prints images from 2 pages arranged on one sheet.
- **4 pages** — Prints images from 4 pages arranged on one sheet.
- **6 pages** — Prints images from 6 pages arranged on one sheet.
- **8 pages** — Prints images from 8 pages arranged on one sheet.
- **9 pages** — Prints images from 9 pages arranged on one sheet.
- **16 pages** — Prints images from 16 pages arranged on one sheet.

### Direction of Print

Sets how the pages are arranged on one sheet.

- **Left to Right** — Arranges pages horizontally from the left and printed top to bottom on one sheet.
- **Right to Left** — Arranges pages horizontally from the right and printed top to bottom on one sheet.
- **Left to Right by column** — Arranges pages vertically from the top and printed left to right on one sheet.
- **Right to Left by column** — Arranges pages vertically from the top and printed right to left on one sheet.

### Draw Borders Around Pages

Prints borders around each page.

### Tip

For the detailed instructions on how to print with the [Number of pages per Sheet] setting, see the following page:

 P.99 “Printing several pages on one sheet”

#### 4. Use Custom Margin

Enables you to set the custom margins. Select this check box and click [Details] to open the dialog box, then set the margin settings.

##### Note

- When [Booklet] is selected from [2-Sided Printing], this option is unavailable.
- Enable this function to add the margins if the application does not support the margin function. When the application has a margin function, use the application's function rather than this option.
- This cannot be used to specify the binding margin for Booklet printing.

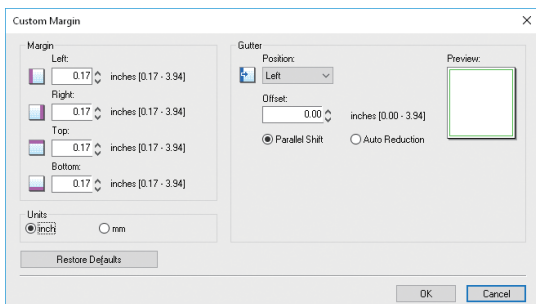

- **Margin** — Enter the value of the left, right, top and bottom margins from 4.2 to 100 mm/ 0.17 to 3.94 inches.
- **Units** — Select the unit, [inch] or [mm], for values.
- **Position** — Select the position of the binding margin from [Left], [Right], [Top] or [Bottom].
- **Offset** — Set the width of the binding margin between 0 and 100 mm (0 and 3.94 inches).
- **Parallel Shift** — The printed image is shifted in accordance with the values set in [Offset]. When [Left] or [Right] is set in [Position], the image shifts to the lateral direction. When [Top] or [Bottom] is set in [Position], the image shifts to the longitudinal direction.

**Example:** When [Left] is set in [Position]

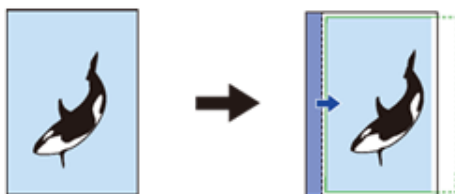

**Example:** When [Top] is set in [Position]

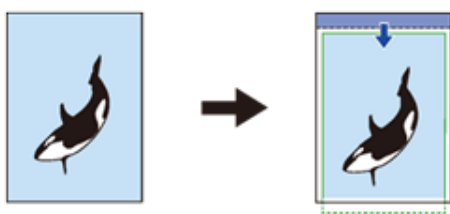

- **Auto Reduction** — Allocate the printed image by reducing its size and printing area automatically so that it can be fitted on the page.

**Example:** When [Left] is set in [Position]



- **Preview** — Displays the preview of the setting result made in [Gutter].  
 Stripe (blue): Position of the binding margin  
 This is displayed when a value of at least 0.1 mm (0.01 inches) is set in [Offset].  
 Arrow (blue): Shifting direction of the printing area  
 Frame (green): Printing area

- **Restore Defaults** — Restores the [Margins] settings to their defaults.

#### Note

If the printing area or the printed image has run off, printing will be performed by cutting off the exceeded portions.

#### Tip

The binding margin on the back side of the paper will be made to the opposite end of the front side in 2-sided printing.

## Booklet Details

In the [Booklet Details] dialog box, you can specify how Booklet printing is performed.

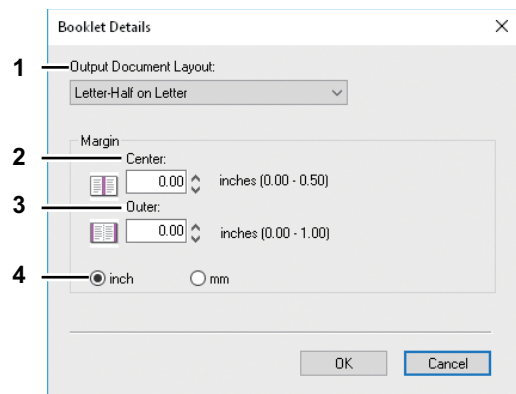

### 1. Output Document Layout

Select the booklet size to be made.

- **A5 on A4** — Select this to print an A5 size booklet. Every 2 pages are printed on A4 paper to fit on half a sheet (A5).
- **A4 on A3** — Select this to print an A4 size booklet. Every 2 pages are printed on A3 paper to fit on half a sheet (A4).
- **B5 on B4** — Select this to print a B5 size booklet. Every 2 pages are printed on B4 paper to fit on half a sheet (B5).
- **B6 on B5** — Select this to print a B6 size booklet. Every 2 pages are printed on B5 paper to fit on half a sheet (B6).
- **1/2 Folio on Folio** — Select this to print a 1/2 Folio size booklet. Every 2 pages are printed on Folio paper to fit on half a sheet.
- **A6 on A5** — Select this to print an A6 size booklet. Every 2 pages are printed on A5 paper to fit on half a sheet (A6).
- **Letter-Half on Letter** — Select this to print a 1/2 Letter size booklet. Every 2 pages are printed on Letter paper to fit on half a sheet.
- **LT on LD** — Select this to print a Letter size booklet. Every 2 pages are printed on Ledger paper to fit on half a sheet (Letter).
- **1/2 LG on LG** — Select this to print a 1/2 Legal size booklet. Every 2 pages are printed on Legal paper to fit on half a sheet.
- **1/2 Statement on Statement** — Select this to print a 1/2 Statement size booklet. Every 2 pages are printed on Statement paper to fit on half a sheet.
- **1/2 Comp on Comp** — Select this to print a 1/2 Computer size booklet. Every 2 pages are printed on Computer paper to fit on half a sheet.
- **1/2 13LG on 13LG** — Select this to print a 1/2 13 inch LG size booklet. Every 2 pages are printed on 13 inch LG paper to fit on half a sheet.
- **1/2 8.5SQ on 8.5SQ** — Select this to print a 1/2 8.5 inch SQ size booklet. Every 2 pages are printed on 8.5 inch SQ paper to fit on half a sheet.
- **32K on 16K** — Select this to print a 32K size booklet. Every 2 pages are printed on 16K paper to fit on half a sheet.
- **16K on 8K** — Select this to print a 16K size booklet. Every 2 pages are printed on 8K paper to fit on half a sheet.

**2. Margin - Center**

This sets the gutter in the center of a 2 facing pages. You can enter the value between 0.00 and 12.70 mm (0.00 and 0.50 inches). The printed images will be reduced according to the margin setting.

**3. Margin - Outer**

This sets the gutter on the outside edges on the page. You can enter the value between 0.00 and 25.40 mm (0.00 and 1.00 inches). The printed images will be reduced according to the margin setting.

**4. Margin - Units**

Select the unit for the Center Margin and Outer Margin option. The default unit varies depending on the regional setting in the Windows.

**Tip**

For detailed instructions on how to print with the [Booklet] setting, see the following page:  
[P.97 “Making a booklet”](#)

**[Image Quality] tab**

The [Image Quality] tab allows you to select how images are printed.

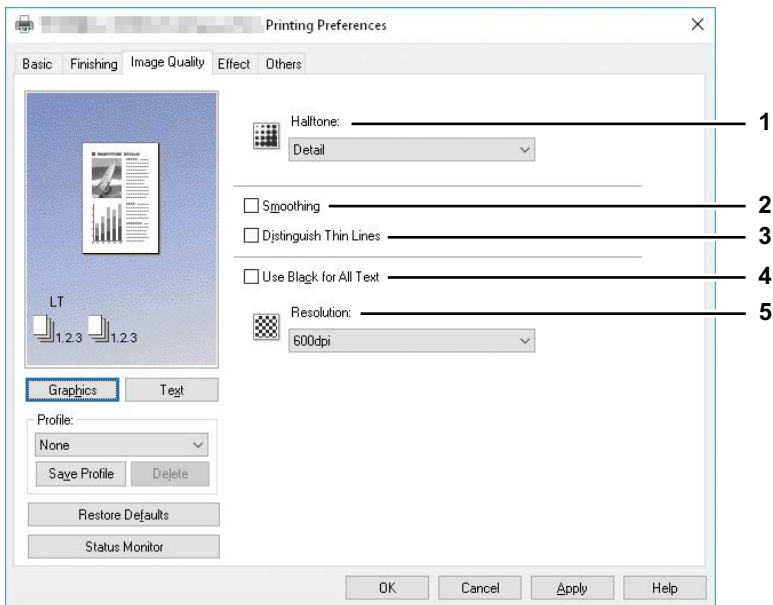

**1. Halftone**

This sets how halftones are printed.

- **Detail** — Select this to print halftone in detail.
- **Smooth** — Select this to print halftone smoothly.

**Note**

This function is not available for the XPS printer driver.

**2. Smoothing**

Select this check box to print texts and graphics smoothly.

**Note**

This function is not available for the XPS printer driver.

**3. Distinguish Thin Lines**

Select this check box to print thin lines clearly.

**Note**

This function is not available for the XPS printer driver.

**4. Use Black for All Text**

Select this check box to print all texts in 100% black except white texts.

## 5. Resolution

300dpi: Prints in 300 x 300 dpi.

600dpi: Prints in 600 x 600 dpi.

### Note

This function is not available for the XPS printer driver.

## □ [Effect] tab

The [Effect] tab contains print options that add effects to your print jobs such as Watermarks and Rotate printing.

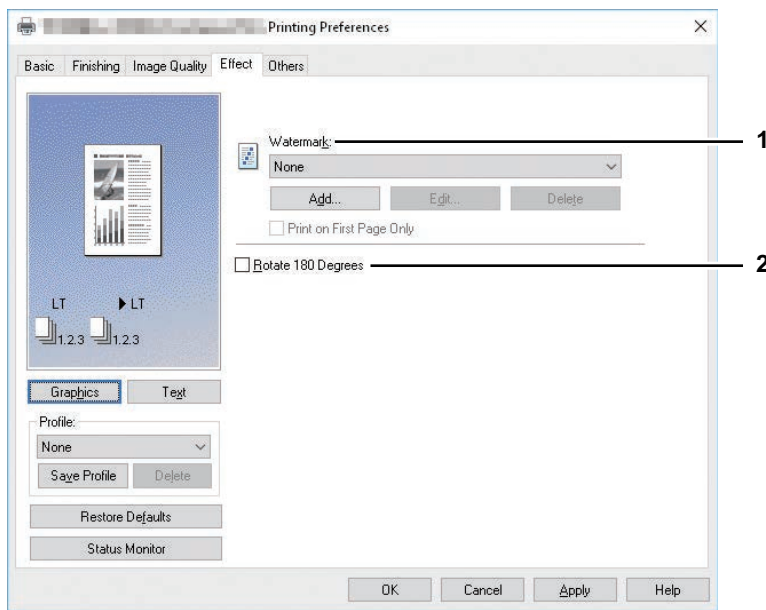

### 1. Watermark

Selects the watermark to be used or edited. The following values except [None] are the default watermarks that have been registered in the printer driver. Up to 15 new watermarks can be added in this box.

- **None** — Select this if no watermark is desired.

The following default watermarks are also displayed in the box:

- TOP SECRET
- CONFIDENTIAL
- DRAFT
- ORIGINAL
- COPY

### Note

This function is not available for the XPS printer driver.

### Tip

For the detailed instructions on how to print with the [Watermark] setting, see the following page:

📖 P.99 “Printing with watermarks”

### [Add]

Creates a new watermark. The [Watermark] dialog box appears when you click on this.

📖 P.89 “Add/Edit Watermark”

### [Edit]

Select a watermark from the [Watermark] box and click it to edit the watermark. The [Watermark] dialog box appears when you click on this.

📖 P.89 “Add/Edit Watermark”

### [Delete]

Select a watermark from the [Watermark] box and click it to delete a watermark.

📖 P.101 “Deleting a watermark”



**Note**

- The default watermarks can be deleted. However, once deleted, they cannot be restored.
- [None] cannot be deleted.

**Print on First Page Only**

Prints a watermark on the first page only. This setting will become available when any watermark is selected from the [Watermark] box.

**2. Rotate 180 Degrees**

Performs rotation printing of an image.

**Add/Edit Watermark**

When you click [Add] or [Edit], the [Watermark] dialog box appears and you can create new watermark or edit selected watermarks.

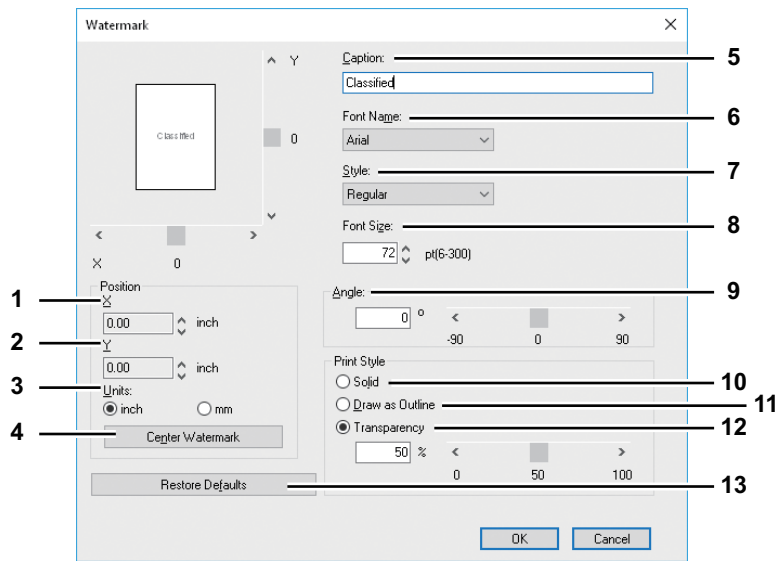

**1. X Position**

The horizontal position of the watermark is displayed. You can change the position using the horizontal scroll bar.

**2. Y Position**

The vertical position of the watermark is displayed. You can change the position using the vertical scroll bar.

**3. Units**

Select the unit for the “X Position” and “Y Position” field.

**4. [Center Watermark]**

Automatically moves the watermark position to the center.

**5. Caption**

Enter the text of a watermark. You can enter up to 63 characters. When you are editing a watermark, the selected watermark text is displayed in the box. The entered text is displayed as the sample image on the left.

**6. Font Name**

Select the font to be used for the watermark text.

**7. Style**

Select the font style for the watermark text.

- **Regular** — Sets the regular style to the text.
- **Bold** — Sets the bold style to the text.
- **Italic** — Sets the italic style to the text.
- **Bold Italic** — Sets the bold and italic style to the text.

**8. Font Size**

Enter the font size for the watermark text. The font size can be set from 6 to 300 pt in increments of 1 pt.

## 9. Angle

Enter the degree of angle for rotating the watermark text. The angle can be set from -90 to 90 degrees in increments of 1 degree. You can also set the degree of the angle by moving the scroll bar.

## 10. Solid

Prints a solid type of watermark.

## 11. Draw as Outline

Prints a outline type of watermark.

## 12. Transparency

Prints a transparent watermark. When you select this, set the brightness from 0 (darker) to 100% (lighter) in increments of 1%. You can also set the brightness using the scroll bar.

## 13. [Restore Defaults]

Restores the settings displayed in the [Watermark] dialog box to the original factory defaults.

## ☐ [Others] tab

The [Others] tab contains print options such as toner saving, and so on.

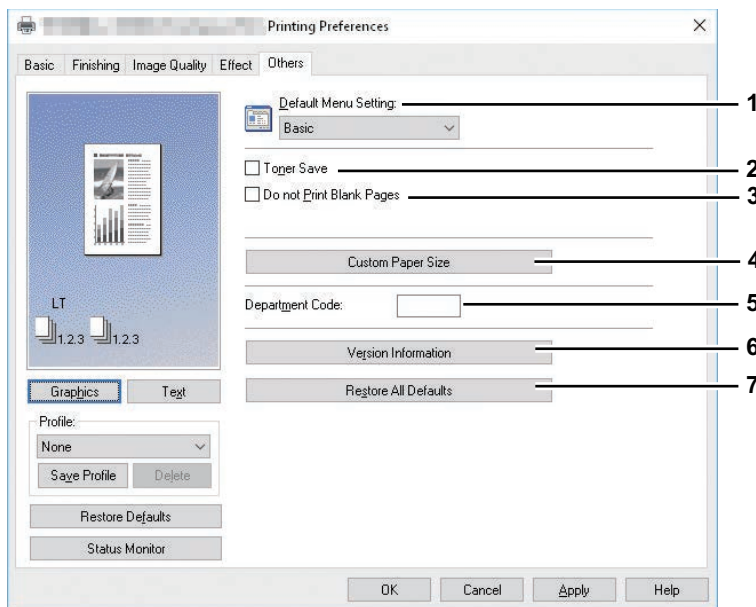

### 1. Default Menu Setting

Select the default tab that is displayed when you open the printing preferences of the printer driver. Set frequently used functions as a default menu setting for your convenience.

#### Note

If you made settings on the [Others] tab menu from the print setting page of the application, they are restored to the defaults when you close the printer driver.

If you want to maintain the settings, set the printer driver from the [Devices and Printers] folder.

📖 P.76 “Setting initial values of print options”

### 2. Toner Save

Prints in the toner save mode.

#### Note

- When the toner save mode is enabled, printing may become lighter.
- This function is not available for the XPS printer driver.

### 3. Do not Print Blank Pages

Select this check box to ignore blank pages for printing.

**Note**

- If the watermark option is enabled, all pages are printed even when the content is blank.
- If the blank pages have a header or footer, they are printed.
- This function is not available for the XPS printer driver.

### 4. Custom Paper Size

Click this to specify the custom paper size. The [Custom Paper Size] dialog box appears when you click this.

P.91 “Custom Paper Size”

**Note**

- In order to set [Custom Paper Size], you must access the printer driver properties from the [Devices and Printers] folder (Windows Server 2008: [Printer]), but not from the [Print] dialog box in the application.
- The [Custom Paper Size] can be set only by an operation with the administrator privilege.
- Paper size cannot be smaller than 100 x 148 mm or larger than 297 x 432 mm.
- This function is not available for the XPS printer driver.

### 5. Department Code

Enter the user’s department code if the equipment is managed with department codes. Please ask your administrator for your department code.  
The department code is a 5-digit number.

### 6. Version Information

Shows the version of the printer driver.

### 7. Restore All Defaults

Restores all print options to the default settings.

Click [OK] on the confirmation dialog box to start restoring or [Cancel] to stop it.

## Custom Paper Size

In the [Custom Paper Size] dialog box, up to 40 custom paper sizes can be defined. The custom page size that you specify can be selected in the [Original Paper Size] and [Print Paper Size] box on the [Basic] tab.

**Tip**

The defined custom paper size setting can be used in common for the PCL6/PS3 printer drivers.

### The [Custom Paper Size - Paper Size List] dialog box

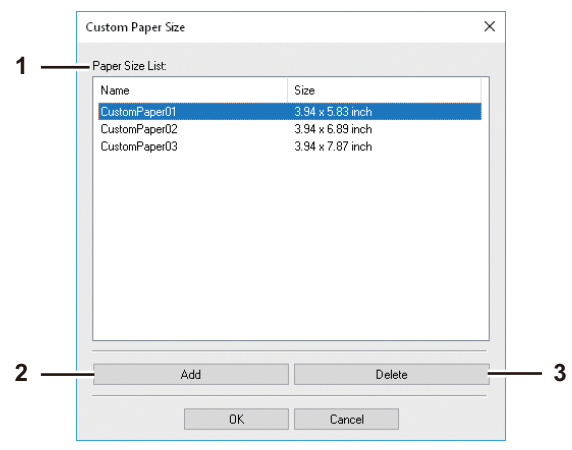

## The [Custom Paper Size - Name] dialog box

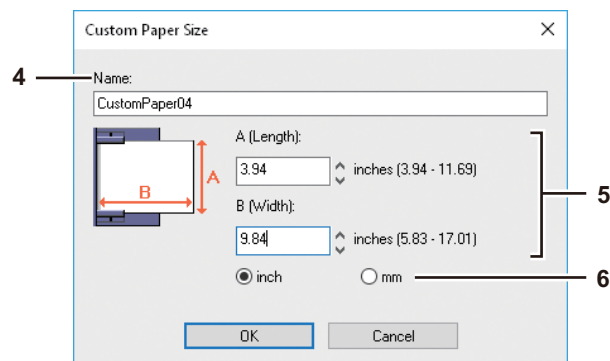

### 1. Paper Size List

Select the custom paper size that you want to modify.

### 2. [Add]

Click this to display the [Custom Paper Size - Name] dialog box.

### 3. [Delete]

Click this to clear and restore the default settings of the selected custom paper size that you selected in the [Paper Size List]. When you click this, the confirmation dialog box appears. Click [Yes] to delete the setting.

### 4. Name

Enter the custom paper size name. You can enter up to 31 characters. This name will be displayed in the [Original Paper Size] and [Print Paper Size] box on the [Basic] tab.

### 5. Paper Size

Enter A (Length) and B (Width) to specify the paper size.

#### Note

The selectable range of A (Length) and B (Width) differs depending on the model. Select values within the range shown on the right of each.

### 6. Units

Select the unit for the paper size. The default unit varies depending on the regional setting in the Windows.

#### Note

- To register a custom paper size, either A (Length) or B (Width) should differ by more than 0.3 inches (7 mm) from the standard paper size. If not, the created custom paper size is considered as the standard paper size.
- You cannot create a custom paper size with A (Length) longer than B (Width). If you want to print such a document, do so by selecting [landscape] for the [Orientation].

## ❑ [Configuration] tab

The [Configuration] tab allows you to configure options. When any optional unit is installed in this equipment, set the configuration of the machine on this tab. The [Configuration] tab can be displayed only from the Printers folder (and not when displaying the properties from the application's print dialog box).

### Note

In order to set the [Configuration] tab, you must access the printer driver properties from the [Devices and Printers] folder (Windows Server 2008: [Printer]). For detailed instructions on how to set the [Configuration] tab, see the following page:

📖 P.68 "Configuring options manually"

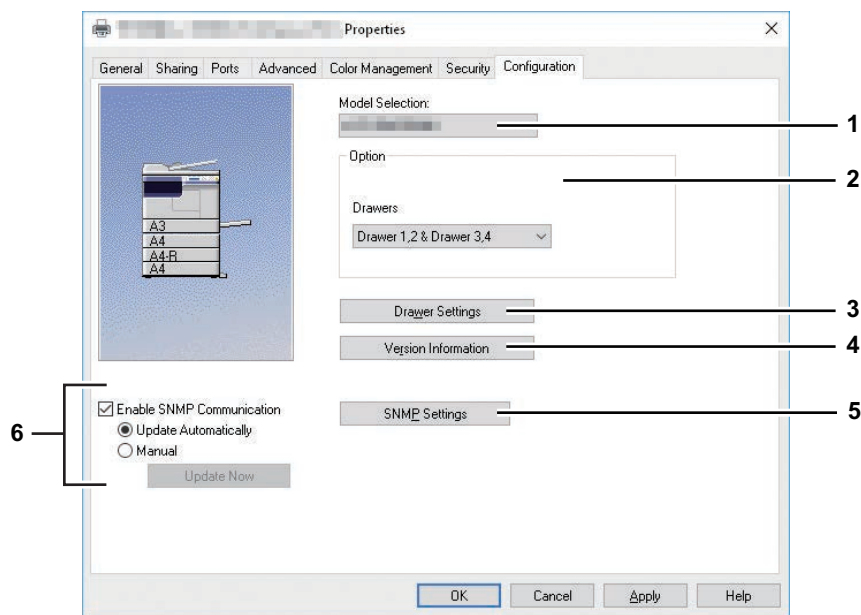

### 1. Model Selection

This sets the model type.

### 2. Option

This option sets whether the following optional devices are installed.

#### Drawers

This sets the installation of drawers according to the configuration.

- **Drawer 1** — Select this when only Drawer 1 is installed.
- **Drawer 1 & Drawer 2** — Select this when Drawers 1 and 2 are installed.
- **Drawer 1, 2 & Drawer 3** — Select this when Drawers 1, 2 and 3 are installed.
- **Drawer 1, 2 & Drawer 3, 4** — Select this when Drawers 1, 2, 3 and 4 are installed.

📖 P.94 "Drawer Settings"

### 3. [Drawer Setting]

Sets the paper size and paper type of each drawer. The [Drawer Settings] dialog box appears by clicking this.

📖 P.94 "Drawer Settings"

### 4. [Version Information]

Displays the [Version Information] dialog box.

### 5. [SNMP Settings]

Click this button when you need to verify or change the SNMP settings.

📖 P.94 "SNMP Settings"

### 6. [Enable SNMP Communication]

This enables SNMP communication between this equipment and your computer to retrieve the option configuration information.

#### Update Automatically/Manual

Select whether to update option configuration information automatically each time the [Configuration] tab of the printer driver is accessed or to update manually.

### [Update Now]

This is available only when [Manual] is selected. Click this to obtain the configuration information from this equipment immediately.

## Drawer Settings

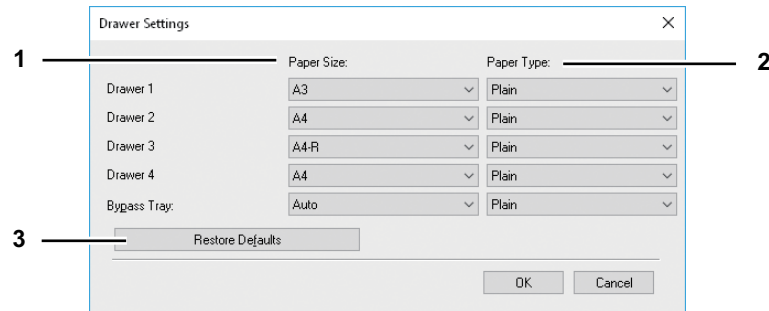

### 1. Paper Size

Select the paper size set in each drawer.

### 2. Paper Type

Select the paper type set in each drawer.

### 3. [Restore Defaults]

Restores the configuration of this equipment displayed in the [Configuration] tab menu to the original factory defaults.

## SNMP Settings

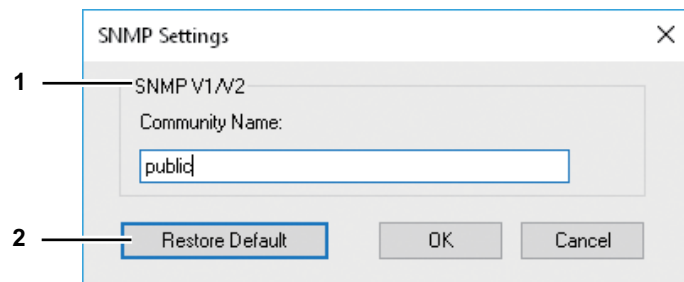

### 1. SNMP V1/V2

**Community Name** — If a community name other than “private” (default) is set for the SNMP community name for your Toshiba MFP, enter its community name.

#### Note

- To find your Toshiba MFP under the SNMP V1/V2 environment, the community names set for the target Toshiba MFP must be specified correctly. For help, consult your administrator.
- To change the community name, the administrator privilege is necessary. You must log in with the “Administrator” privilege and open the printer driver properties.
- Up to 31 characters including the following symbols can be entered for the Community Name.  
! " # \$ % & ' ( ) \* + , - / : ; < = > ? @ [ \ ] ^ \_ ` { | } ~

### 2. [Restore Defaults]

Click this button when you want to reset all the settings back to the defaults.

# Printing With Best Functions for Your Needs

In this section, procedures are given to print various types of print jobs, using the layout and finishing options. Read this section before starting printing and select the procedure best suited for your needs.

- 📖 P.95 “Layout and finishing options in [Basic] tab menu”
- 📖 P.96 “Layout and finishing options in [Finishing] tab menu”
- 📖 P.99 “Finishing options in [Effect] tab menu”

## ■ Layout and finishing options in [Basic] tab menu

Using the printer driver, you can set various layout options to suit your preferences. In this section various printing functions enabled with the [Basic] tab menu are explained.

- 📖 P.95 “Fitting images within paper size”

### ❑ Fitting images within paper size

Automatically enlarges or reduces an image to fit into a specified paper size, or manually set the scale to enlarge or reduce it.

#### Printing enlarged or reduced image to fit the specified paper size

- 1 Display the [Basic] tab menu.
- 2 Select the document size on the [Original Paper Size] box. Then select the paper size that you want to print at the [Print Paper Size] box.

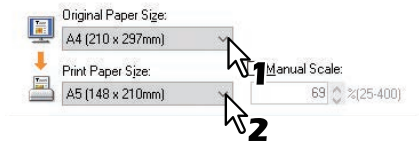

The document image is automatically enlarged or reduced depending on the original paper size and print paper size.

- 3 Set any other print options and click [OK].
- 4 Click [OK] or [Print] to send the print job.

#### Printing an enlarged or reduced image by specifying the scale manually

- 1 Display the [Basic] tab menu.
- 2 Check the [Manual Scale] box. Then enter the scale.

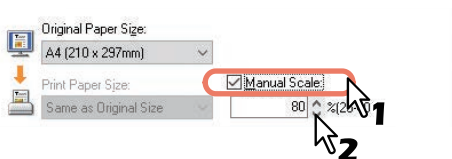

The scale can be set from 25% to 400% in units of 1%.

- 3 Set any other print options and click [OK].
- 4 Click [OK] or [Print] to send the print job.

## ■ Layout and finishing options in [Finishing] tab menu

Using the printer driver, you can set various layout options to suit your preferences. In this section various printing functions enabled with the [Finishing] tab menu are explained.

- 📖 P.96 “Sort printing”
- 📖 P.97 “Printing on both sides of paper”
- 📖 P.97 “Making a booklet”
- 📖 P.99 “Printing several pages on one sheet”

### □ Sort printing

Selects how multiple copies of a document to be output, such as separately for each copy and grouping each page.

#### Sorting printed documents according to the copies

- 1** Display the [Basic] tab menu.
- 2** Enter the number of copies to be printed at the [Number of Copies] box.



- 3** Display the [Finishing] tab menu.
- 4** Select [Sort Copies] icon at [Copy Handling].



- 5** Set any other print options and click [OK].
- 6** Click [OK] or [Print] to send the print job.

#### Sorting printed documents according to the pages

For example, assume that you have a three-page job (A, B, C) and you want three copies of each page in this order (AAA, BBB, CCC).

- 1** Display the [Basic] tab menu.
- 2** Enter the number of copies to be printed at the [Number of Copies] box.



- 3** Display the [Finishing] tab menu.
- 4** Select [Group Copies] icon at [Copy Handling].



- 5** Set any other print options and click [OK].
- 6** Click [OK] or [Print] to send the print job.

#### Sorting printed documents horizontally and vertically for each copy

##### Note

- Rotated Sort Copies can be enabled only when printing on A4, B5, Letter, or 16K.
- To make Rotated Sort Copies, sheets to be used must be placed both horizontally and vertically (example: A4 and A4-R).



- 1** Display the [Basic] tab menu.
- 2** Enter the number of copies to be printed at the [Number of Copies] box.

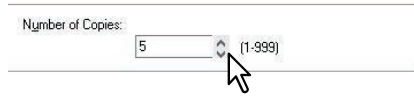

- 3** Display the [Finishing] tab menu.
- 4** Select [Rotated Sort] icon at [Copy Handling].



- 5** Set any other print options you require and click [OK].
- 6** Click [OK] or [Print] to send the print job.  
The printed documents are alternately sorted horizontally and vertically for each copy.

**❑ Printing on both sides of paper**

You can print on both sides of the paper.

- 1** Open the [Basic] tab to select the following settings.
  - Any paper size other than envelopes from the [Print Paper Size] list. You cannot use envelopes.
  - [Plain] from the [Paper Type] list. You cannot use other paper sizes.
- 2** Open the [Finishing] tab, select the [2-Sided Printing] check box, and select the binding position icon.



**Long Edge** — Select this to print on both sides of the paper with a margin on the long edge.  
**Short Edge** — Select this to print on both sides of the paper with a margin on the short edge.  
**Booklet** — Select this to print a properly paginated booklet or magazine-style publication.

**Tip**

You can also set booklet printing at the [2-Sided Printing] option by selecting the [Booklet] icon. For instructions on how to perform booklet printing, see the following section.  
 📖 P.97 “Making a booklet”

- 3** Set any other print options you require and click [OK].
- 4** Click [OK] or [Print] to start the print job.  
The print job is printed on both sides of paper in the specified direction.

**❑ Making a booklet**

You can create a document in a book- or magazine-style publication by selecting the Booklet option.

**Creating a booklet**

- 1** Display the [Finishing] tab menu.
- 2** Select the [2-Sided Printing] check box and select the [Booklet] icon.



### 3 Click [Details].

The [Booklet Details] dialog box appears.

### 4 Select the booklet size at the [Output Document Layout] box.

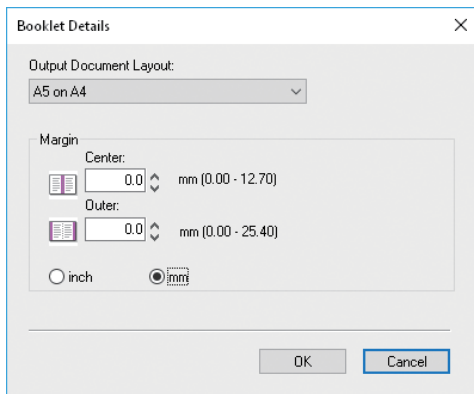

**A5 on A4** — Select this to print an A5 size booklet. Every 2 pages are printed on A4 paper to fit on half a sheet (A5).

**A4 on A3** — Select this to print an A4 size booklet. Every 2 pages are printed on A3 paper to fit on half a sheet (A4).

**B5 on B4** — Select this to print a B5 size booklet. Every 2 pages are printed on B4 paper to fit on half a sheet (B5).

**B6 on B5** — Select this to print a B6 size booklet. Every 2 pages are printed on B5 paper to fit on half a sheet (B6).

**1/2 Folio on Folio** — Select this to print a 1/2 Folio size booklet. Every 2 pages are printed on Folio paper to fit on half a sheet.

**A6 on A5** — Select this to print an A6 size booklet. Every 2 pages are printed on A5 paper to fit on half a sheet (A6).

**Letter-Half on Letter** — Select this to print a 1/2 Letter size booklet. Every 2 pages are printed on Letter paper to fit on half a sheet.

**LT on LD** — Select this to print a Letter size booklet. Every 2 pages are printed on Ledger paper to fit on half a sheet (Letter).

**1/2 LG on LG** — Select this to print a 1/2 Legal size booklet. Every 2 pages are printed on Legal paper to fit on half a sheet.

**1/2 Statement on Statement** — Select this to print a 1/2 Statement size booklet. Every 2 pages are printed on Statement paper to fit on half a sheet.

**1/2 Comp on Comp** — Select this to print a 1/2 Computer size booklet. Every 2 pages are printed on Computer paper to fit on half a sheet.

**1/2 13LG on 13LG** — Select this to print a 1/2 13 inch LG size booklet. Every 2 pages are printed on 13 inch LG paper to fit on half a sheet.

**1/2 8.5SQ on 8.5SQ** — Select this to print a 1/2 8.5 inch SQ size booklet. Every 2 pages are printed on 8.5 inch SQ paper to fit on half a sheet.

**32K on 16K** — Select this to print a 32K size booklet. Every 2 pages are printed on 16K paper to fit on half a sheet.

**16K on 8K** — Select this to print a 16K size booklet. Every 2 pages are printed on 8K paper to fit on half a sheet.

### 5 If you want to add a margin space between facing pages, enter a width in the [Center] box, and if you want to add a margin on the outside edge, enter a width in the [Outer] box.

- You can change the unit of the margin at the [Units].
- The center margin can be set from 0.00 mm to 12.70 mm in units of 0.10 mm when the unit is mm, and from 0.00 inch to 0.50 inches in units of 0.01 inch when the unit is inches. The printed images will be reduced according to the margin setting.
- The outer margin can be set from 0.00 mm to 25.40 mm in units of 0.10 mm when the unit is mm, and from 0.00 inch to 1.00 inches in units of 0.01 inch when the unit is inches. The printed images will be reduced according to the margin setting.

### 6 Click [OK] to close the [Booklet Details] dialog box.

### 7 Set any other print options you require and click [OK].

### 8 Click [OK] or [Print] to send the print job.

The print job is printed as a booklet.

## ❑ Printing several pages on one sheet

Prints several pages of a document on one sheet of paper (N-up feature). This feature is very useful for browsing a large number of pages for appearance or page order. For example, to check the navigation path of a number of web pages or review the narrative of a slide presentation, using N-up is not only convenient but conserves paper as well.

### Printing multiple pages per sheet

- 1 Display the [Finishing] tab menu.
- 2 Select how many pages you want to print on a single sheet at the [Number of pages per Sheet] box.



- 2 pages** — Prints images from 2 pages arranged on one sheet.
- 4 pages** — Prints images from 4 pages arranged on one sheet.
- 6 pages** — Prints images from 6 pages arranged on one sheet.
- 8 pages** — Prints images from 8 pages arranged on one sheet.
- 9 pages** — Prints images from 9 pages arranged on one sheet.
- 16 pages** — Prints images from 16 pages arranged on one sheet.

- 3 Select how the pages are arranged on one sheet in the [Direction of Print] option.



- Left to Right** — Arranges pages horizontally from the left and printed top to bottom on one sheet.
- Right to Left** — Arranges pages horizontally from the right and printed top to bottom on one sheet.
- Left to Right by column** — Arranges pages vertically from the top and printed left to right on one sheet.
- Right to Left by column** — Arranges pages vertically from the top and printed right to left on one sheet.

#### Tip

Items that can be selected in [Direction of print] may vary depending on the number of pages selected at the [Number of pages per Sheet] box.

- 4 If you want to draw a line around each page, select the [Draw Borders Around Pages] check box.
- 5 Set any other print options and click [OK].
- 6 Click [OK] or [Print] to send the print job.

## ■ Finishing options in [Effect] tab menu

Using the printer driver, you can set various layout options to suit your preferences. In this section various printing functions enabled with the [Effect] tab menu are explained.

📖 P.99 “Printing with watermarks”

## ❑ Printing with watermarks

Watermarks overprint your document with useful information, such as [TOP SECRET], [CONFIDENTIAL], [DRAFT], [ORIGINAL], or [COPY]. You can choose from several predefined watermarks or you can create and save your own custom watermarks.

Watermarks are text only.

### Printing a watermark

- 1 Display the [Effect] tab menu.

**2 Select the watermark to be printed at the [Watermark] box.**

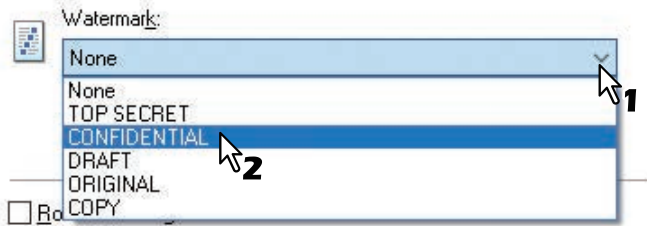

**Note**

You can create a new watermark if there is none you want to apply on the box.  
P.100 “Creating or editing a watermark”

**3 If you want to print the watermark on only the first page, select the [Print on First Page Only] check box.**

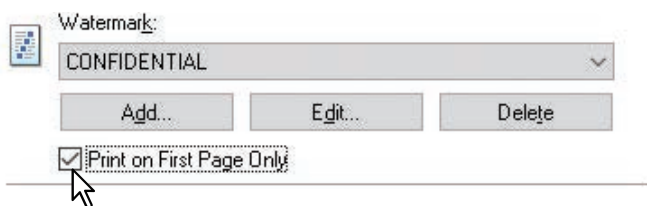

**4 Set any other print options and click [OK].**

**5 Click [OK] or [Print] to send the print job.**

**Creating or editing a watermark**

**1 Click [Add] to create a new watermark, or select one that you want to edit and click [Edit] to edit a watermark.**



The [Watermark] dialog box appears.

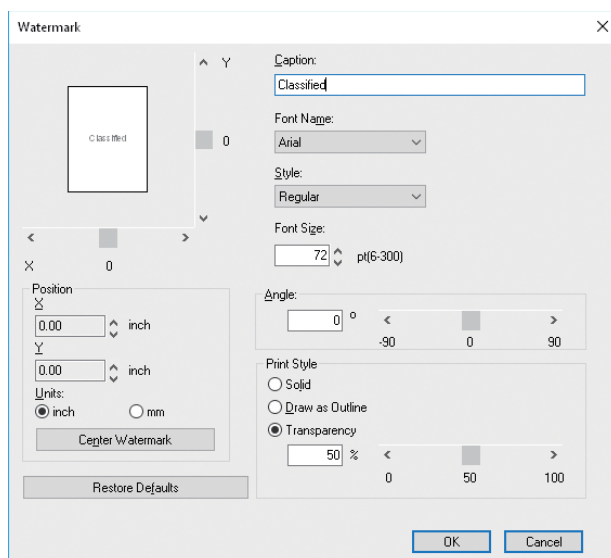

**2 Enter the watermark text in the [Caption] box.**

You can enter up to 63 characters for the [Caption] box. However, if too many characters are entered, the watermark may not be printed correctly.

- 3 Select a font for the watermark at the [Font Name] box.**
- 4 Select a font style for the watermark at the [Style] box.**
- 5 Enter the font size in the [Font Size] box.**  
You can enter any integer between 6 and 300pt in units of 1pt.
- 6 To rotate the watermark, enter the number of degrees in the [Angle] box.**
  - You can enter from -90 degrees to 90 degrees in units of 1 degree in the [Angle] box.
  - You can also set the angle using the scroll bar.
- 7 Select how the watermark text is printed from [Solid], [Draw as Outline], and [Transparency].**  
**Solid** — Prints a solid type of watermark.  
**Draw as Outline** — Prints an outline type of watermark.  
**Transparency** — Prints a transparent watermark. Set the transparent ratio from 0 to 100% in units of 1%. You can also set the transparent ratio using the scroll bar.
- 8 Enter the X and Y values or move the scroll bar to adjust the watermark position.**
  - You can adjust the position horizontally with “X” and vertically with “Y”.
  - You can select the unit, [inch] or [mm].
  - Click [Center Watermark] to locate the watermark text to the middle horizontally and vertically.
- 9 Click [OK] to save the watermark settings.**

### Deleting a watermark

**Note**

You can delete the default watermarks. However, they cannot be restored by clicking [Restore Defaults].

- 1 Select the watermark that you want to delete at the [Watermark] box.**

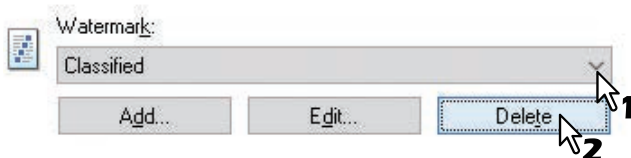

- 2 Click [Delete].**  
The [Confirm Delete] dialog box appears.

- 3 Click [Yes].**

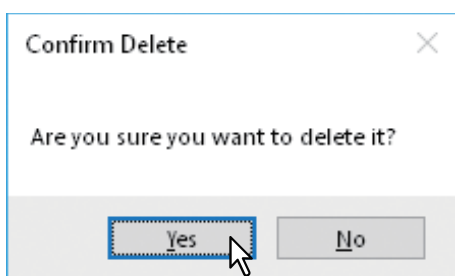



## PRINT FUNCTIONS (macOS)

<b>Printing from Application</b> .....	<b>104</b>
Considerations and limitations.....	104
How to print .....	104
<b>Setting up Print Options</b> .....	<b>106</b>
[Page Setup] options .....	106
[Print] options .....	108

## Printing from Application

---

This section explains printing from OS X 10.11 to macOS 10.14.

📖 P.104 “Considerations and limitations”

📖 P.104 “How to print”

### ■ Considerations and limitations

Some print options can be set from both the application and the printer driver, such as collation. If the collation is set from the application, documents may not be properly printed. If that happens, use the printer driver to set the collation. Depending on the application, some print options such as the orientation need to be set from the application. For print options that can be set from both the application and the driver, refer to the manual of the application.

### ■ How to print

All printers are managed under [Print & Fax]/[Printers & Scanners] of [System Preferences]. Once a printer is added to the printer list, you can select any printer directly from the [Page Setup] dialog box or the [Print] dialog box.

In macOS applications, print options are set from both the [Page Setup] dialog box and the [Print] dialog box.

#### Tip

- When you create a document, you usually set page attributes such as paper size and orientation from within your application, which are linked to the [Page Setup] options.
- Some of the [Print] options vary from application to application.

### □ Printing from macOS application

**1** Open a file and select [Page Setup] from the [File] menu of the application.

**2** Select a name of your printer from [Format For] and set or make sure of the page attributes for the file.

📖 P.106 “[Page Setup] options”

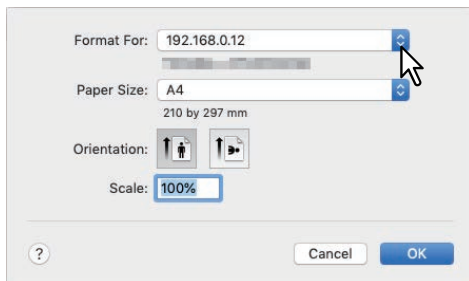

**3** Click [OK] to save the page attributes.

**4** Select [Print] from the [File] menu of the application.



## 5 Make sure of your printer name at [Printer] and set the options to print the file.

 P.108 “[Print] options”

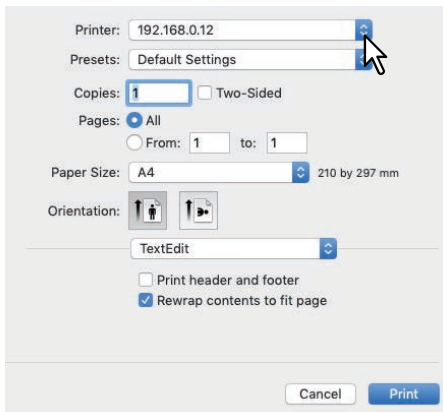

### Tip

You can preset the options set in the [Print] dialog box. Select [Save as] from the [Presets] menu and save them under a new name. When you use the preset options, select the preset name from the [Presets] menu.

## 6 Click [Print] to print the file.

## Setting up Print Options

When you print a document from macOS, you need to set up page and print options.

📖 P.106 “[Page Setup] options”

📖 P.108 “[Print] options”

### ■ [Page Setup] options

When you create a document to print, select [Page Setup] from the [File] menu of your application to open the [Page Setup] dialog box and set the page attributes. When necessary, you can define custom page sizes other than standard ones.

📖 P.106 “Page Attributes”

📖 P.107 “Custom page sizes”

#### Tip

When you create a document, you usually set page attributes such as paper size and orientation from within your application, which are linked to the [Page Setup] options.

### □ Page Attributes

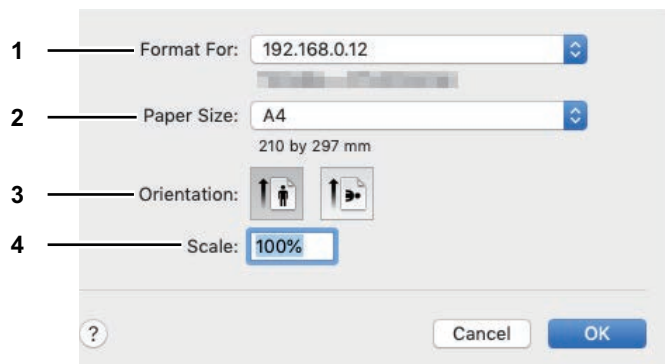

#### 1. Format For

Select a name of your printer to use for printing.

#### 2. Paper Size

Select a paper size to print your document. Available paper sizes are listed below:

- A4 (210 x 297 mm)
- A5 (148 x 210 mm)
- A3 (297 x 420 mm)
- JIS B4 (257 x 364 mm)
- JIS B5 (182 x 257 mm)
- Folio (210 x 330 mm)
- J Post Card (100 x 148 mm)
- US Letter (8 1/2 x 11")
- US Legal (8 1/2 x 14")
- Ledger (11 x 17")
- Statement (5 1/2 x 8 1/2")
- Computer (10 1/8 x 14")
- 13" LG (8 1/2 x 13")
- 8.5" SQ (8 1/2 x 8 1/2")
- 16K (195 x 270 mm)
- 8K (270 x 390 mm)
- Env-Com10 (4 1/8 x 9 1/2")
- Envelope Monarch (3 7/8 x 7 1/2")
- Envelope DL (110 x 220 mm)
- Envelope Choukei 3 (120 x 235 mm)
- Envelope You4 (105 x 235 mm)

#### 3. Orientation

Set the paper direction to print a document.

- **Portrait** — A document is printed in the portrait direction.
- **Landscape (90 degree)** — A document is printed in the landscape direction from the left.

#### 4. Scale

Change an image size to print on a page. Enter a scale to enlarge or reduce an image. You can set any integer from 1% to 999%.

## ❑ Custom page sizes

You can define custom page sizes other than standard ones.

### Note

- When you print on paper longer than standard sizes, print one sheet at a time.
- Paper size cannot be smaller than 100 x 148 mm or larger than 297 x 432 mm.

### Creating a custom page size

#### 1 Select [Manage Custom Sizes] from the [Paper Size] menu.

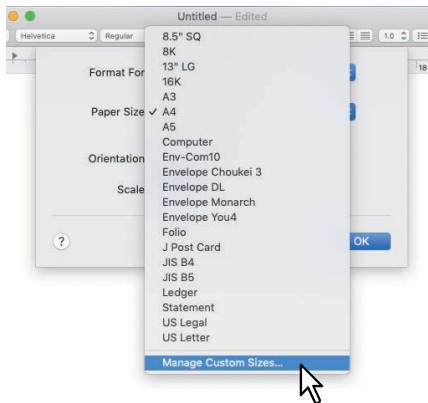

#### 2 Click [+].

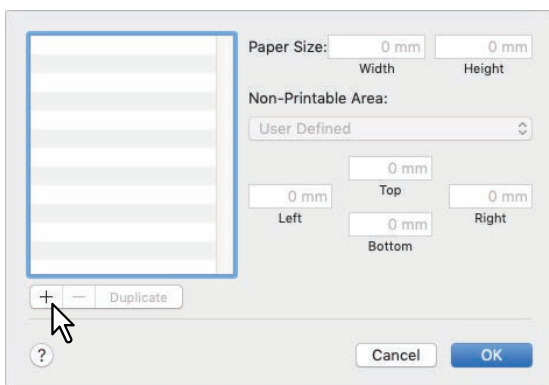

A new custom page size name is added to the list.

### Tip

If you want to create a new custom page size by duplicating an existing custom page size, select a custom page size name on the list and click [Duplicate].

#### 3 Double-click the added custom page size name on the list and rename the custom page size.

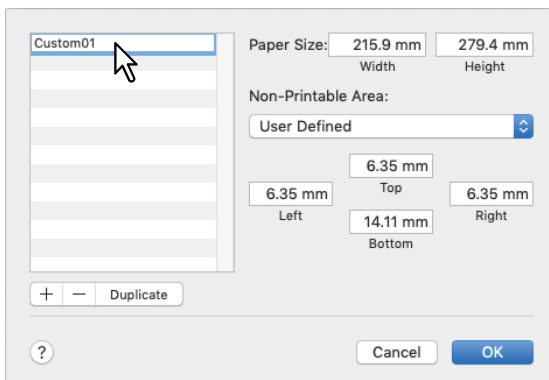

#### 4 Select a name of your printer from the [Non-Printable Area] menu and enter the width and height in the [Paper Size] boxes.

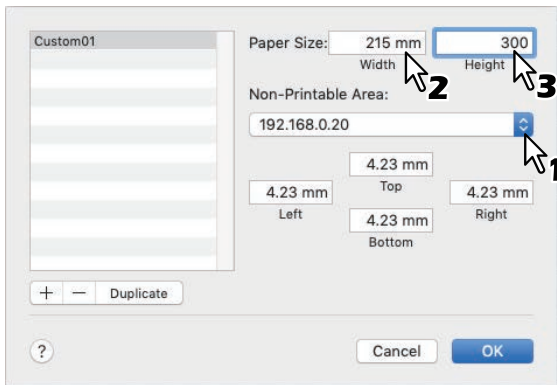

##### Tip

- Use the minimum margin values that are automatically set by selecting the printer name, or you can set values larger than the minimum ones for wider margins.
- You can delete the created custom page size by selecting the name and clicking [-].

#### 5 Click [OK].

You can select the saved custom page size from the [Paper Size] menu.

### ■ [Print] options

When you print a document, select [Print] from the [File] menu of your application. You can set the following print options.

- 📖 P.108 “Copies & Pages”
- 📖 P.109 “Layout”
- 📖 P.110 “Paper Handling”
- 📖 P.111 “Paper Feed”
- 📖 P.112 “Cover Page”
- 📖 P.112 “Printer Features”

##### Tip

- Some of the [Print] options vary from application to application.
- The options and arrangement vary from macOS version to version.

### □ Copies & Pages

In the [Print] dialog box, you must first set basic print options such as the number of copies, the range to print pages, sort printing, and two-sided printing.

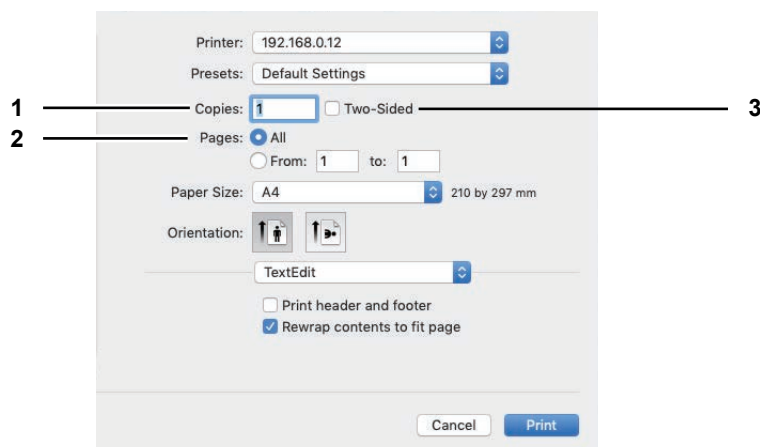

#### 1. Copies

Set the number of copies to print a document.

**2. Pages**

Set the range of pages to print a document.

- **All** — Select this option to print all pages.
- **From/to** — Select this option to print a range of pages. Enter the start and last page numbers.

**3. Two-Sided**

Select this check box to print on both sides of paper, called “two-sided printing”. When you select this check box, [Long-Edge binding] is automatically selected from [Two-Sided] in the [Layout] menu.

**Layout**

In the [Layout] menu, you can set the print options to print multiple pages per sheet, which is called “N-up printing”.

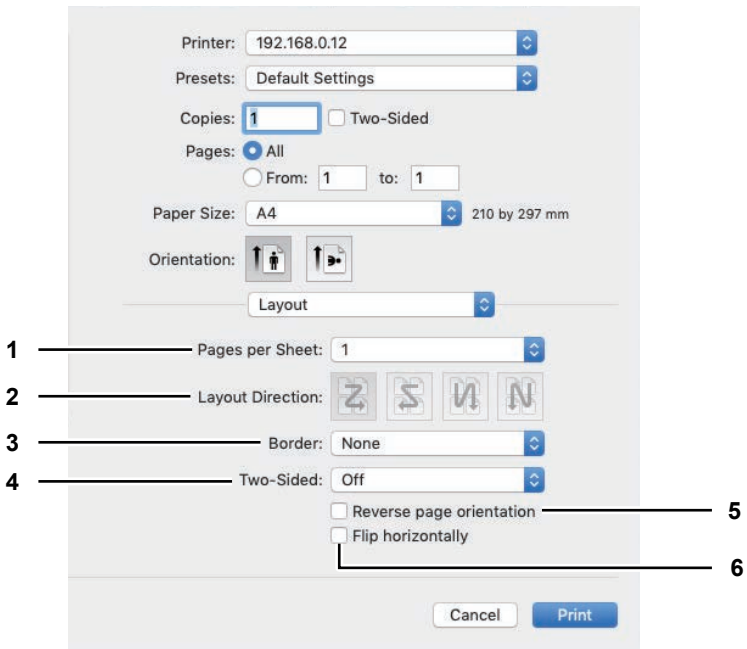

**1. Pages per Sheet**

Set the number of pages to print on a sheet of paper. Pages are automatically reduced to fit the selected paper size.

- **1** — Select this value to print a page on a sheet, which is normal printing.
- **2** — Select this value to print 2 pages arranged on a sheet.
- **4** — Select this value to print 4 pages arranged on a sheet.
- **6** — Select this value to print 6 pages arranged on a sheet.
- **9** — Select this value to print 9 pages arranged on a sheet.
- **16** — Select this value to print 16 pages arranged on a sheet.

**2. Layout Direction**

Set how pages are arranged on a sheet. You can set this option only for N-up printing.

- **Across Left to Right Before Down** — Pages are arranged horizontally from left to right and then top to bottom on a sheet.
- **Across Right to Left Before Down** — Pages are arranged horizontally from right to left and then top to bottom on a sheet.
- **Down Before Across Left to Right** — Pages are arranged vertically from top to down and then left to right on a sheet.
- **Down Before Across Right to Left** — Pages are arranged vertically from top to down and then right to left on a sheet.

**3. Border**

Select a type of the border line around each page for N-up printing.

- **None** — Select this option if no border line is to be drawn.
- **Single Hairline** — Select this option to draw a single hairline around each page.
- **Single Thin Line** — Select this option to draw a single thin line around each page.
- **Double Hairline** — Select this option to draw a double hairline around each page.

- **Double Thin Line** — Select this option to draw a double thin line around each page.

#### 4. Two-Sided

Turn on or off printing on both sides of paper, which is called “two-sided printing”. You can select the binding position for two-sided printing.

- **Off** — Select this option to print on a single side of paper, which is normal single-sided printing.
- **Long-Edge binding** — Select this option to turn on two-sided printing for binding along the long edge of paper. The print direction on the back side of paper differs depending on the orientation.

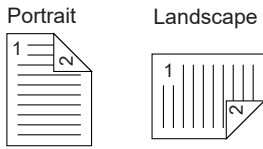

- **Short-Edge binding** — Select this option to turn on two-sided printing for binding along the short edge of paper. The print direction on the back side of paper differs depending on the orientation.

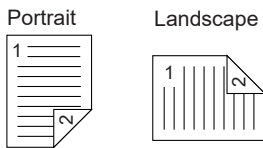

#### 5. Reverse page orientation

Select this check box to reverse the page orientation. If you load paper in the opposite direction for any reason, you can print pages upside down for correct printing.

#### 6. Flip horizontally

Select this check box to flip pages horizontally for printing.

### Paper Handling

In the [Paper Handling] menu, you can set the options to handle paper such as collating pages, reversing the order of pages, printing odd or even pages, and printing by enlargement/reduction.

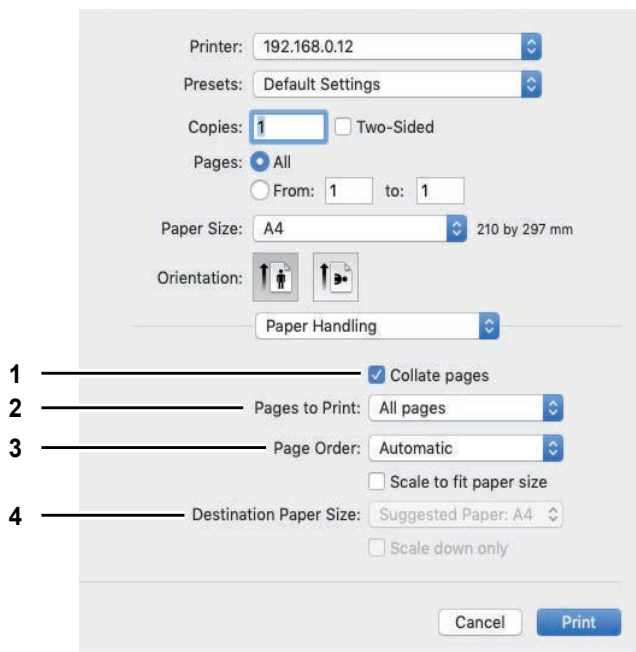

#### 1. Collate pages

Select this check box to collate pages in order when printing two or more copies: all the pages of one copy are printed before the next copy is printed. It is called “sort-printing” (1, 2, 3, ... ; 1, 2, 3, ...).

#### 2. Pages to Print

Select one of the options to print all pages, or only odd or even pages.

### 3. Page Order

Select the page order for printing. Select [Automatic] or [Normal] to print from the first page to the last one. Select [Reverse] to print from the last page to the first one.

### 4. Destination Paper Size

Print at the original paper size you have set for the document or print by scaling according to the selected paper size.

- **Scale to fit paper size** — Click to clear this check box to print at the original paper size. Select this check box so that you can select a paper size from the menu to scale the original paper size to fit the selected one for printing. If you do not want to enlarge the size when you select any larger paper size than the original one, select the [Scale down only] check box, so that you can print the document at its original size.

## ❑ Paper Feed

In the Paper Feed menu, you can set the paper source.

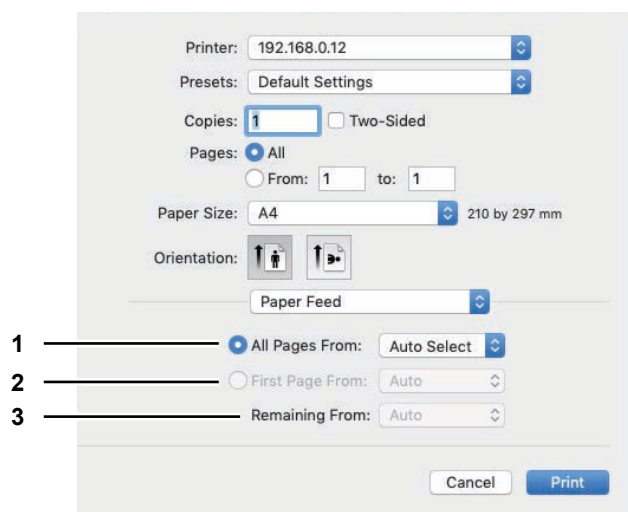

#### 1. All pages from

Select this when you want to use the same paper source for all pages. You can select the paper source to be used at the box. When you select [Auto Select], paper will be fed from the drawer with the paper size which is the same as that for an original. When you select [Bypass Tray], place paper on the bypass tray to perform printing.

#### 2. First Page From

Select this when you want to specify different paper sources for the first page and remaining pages. When this is selected, specify the paper source to be used for the first page at the box. When you select [Auto Select], paper will be fed from the drawer with the paper size which is the same as that for an original. When you select [Bypass Tray], place paper on the bypass tray to perform printing.

#### 3. Remaining From

Specify the paper source to be used for the remaining pages at the box when the [First Page From] option button is selected. When you select [Auto Select], paper will be fed from the drawer with the paper size which is the same as that for an original. When you select [Bypass Tray], place paper on the bypass tray to perform printing.

## ❑ Cover Page

In the [Cover Page] menu, you can set the options to print a cover page. The cover page includes information such as job ID, title, print owner, print source, and billing information.

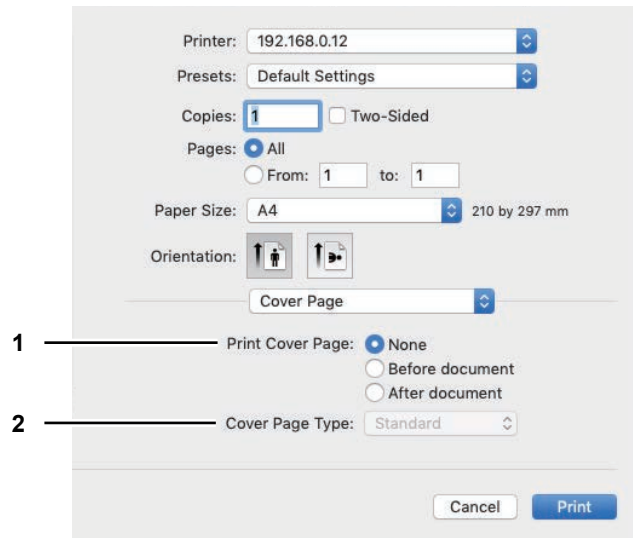

### 1. Print Cover Page

Select a position to print a cover page.

- **None** — Select this option to print the document without a cover page.
- **Before document** — Select this option to print a cover page before the document.
- **After document** — Select this to print a cover page after the document.

### 2. Cover Page Type

Specify the type for a cover page when you have selected the [Before document] or [After document] option button in [Print Cover Page].

## ❑ Printer Features

In the [Printer Features] menu, you can select the following sets from the [Feature Sets] menu and set the options that control the printer features.

- 📖 P.113 “General”
- 📖 P.113 “Printing Modes”
- 📖 P.114 “Printing Modes DC”
- 📖 P.115 “Quality”



## General

You can set a media source and type, duplex printing, and resolution.

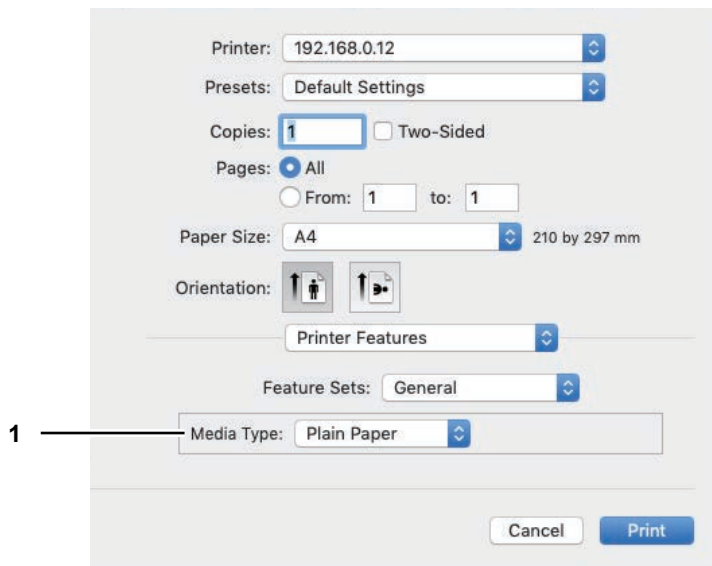

### 1. Media Type

Select a media type from “Printer’s Default”, “Plain Paper”, “Thick”, “Thick 1”, “Thick 2”, “Transparency”, “Thin”, or “Envelope”. “Printer’s Default” is a default set on the equipment.

## Printing Modes

You can set the printing modes for department codes, thin lines, and no blank pages.

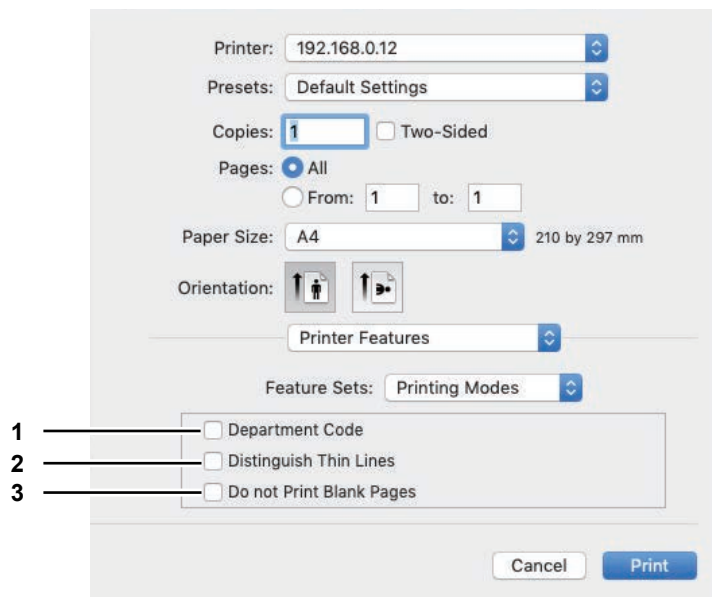

### 1. Department Code

Select this option if the equipment is managed with specific department codes and you need one for printing.

#### Tip

Select [Printing Modes DC] and set the department code that you need for printing.

### 2. Distinguish Thin Lines

Select this option to print thin lines clearly.

### 3. Do not Print Blank Pages

Select this option to skip blank pages for printing.

## Printing Modes DC

You can set a department code to print documents. For the necessary department code, consult your administrator.

### Tip

Select [Printing Modes] and set [Department Code] to print documents with the department code.

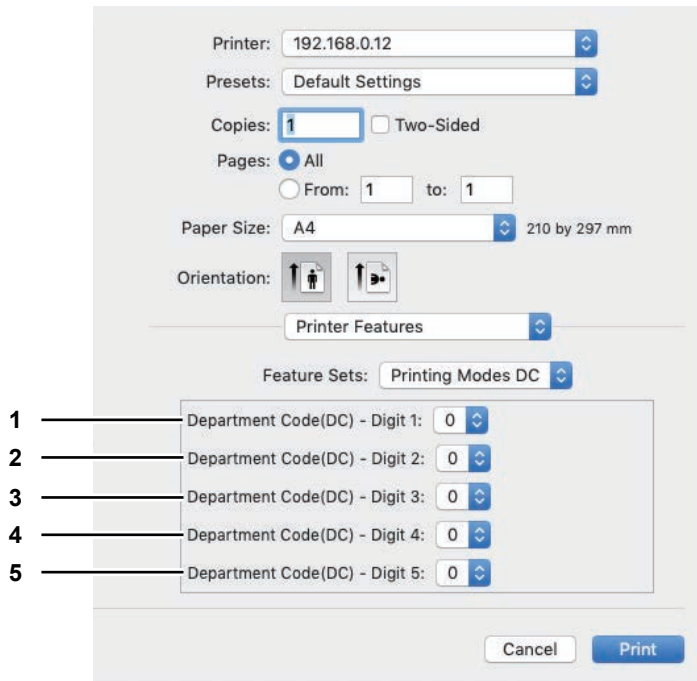

- 1. Department Code(DC) - Digit 1**  
Select the first digit of your department code from 0 to 9.
- 2. Department Code(DC) - Digit 2**  
Select the second digit of your department code from 0 to 9.
- 3. Department Code(DC) - Digit 3**  
Select the third digit of your department code from 0 to 9.
- 4. Department Code(DC) - Digit 4**  
Select the fourth digit of your department code from 0 to 9.
- 5. Department Code(DC) - Digit 5**  
Select the fifth digit of your department code from 0 to 9.

## Quality

You can set print quality.

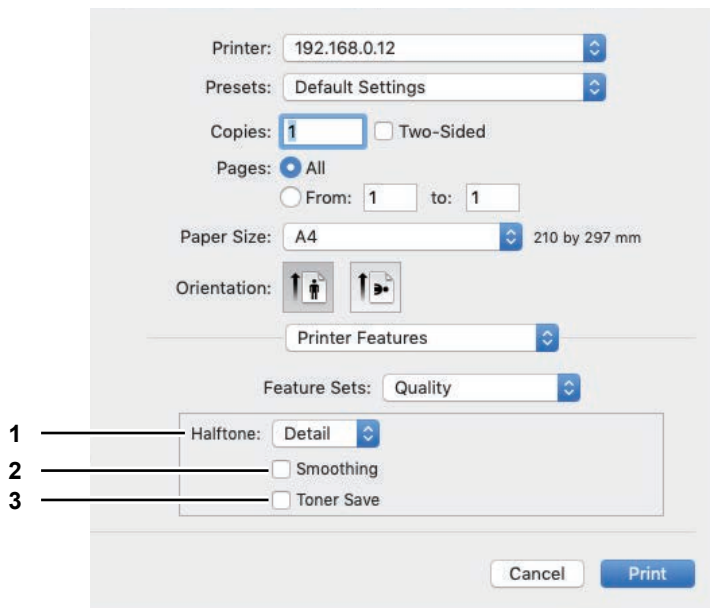

### 1. Halftone

This sets how halftones are printed.

- **Detail** — Select this to print halftone in detail.
- **Smooth** — Select this to print halftone smoothly.

### 2. Smoothing

Select this option to print text and graphics smoothly.

### 3. Toner Save

Select this option to save toner for printing.

#### Note

The toner save option might make printed images pale.



## SCAN FUNCTIONS

<b>Scanning From Application .....</b>	<b>118</b>
How to scan.....	118
<b>Setting up Scan Options.....</b>	<b>120</b>
Scan options.....	120
Scanning from the equipment on the network.....	123
Scanning from the equipment connected by USB cable.....	123
Using the Easy Set feature.....	124
<b>Scanning from e-STUDIO Scan Editor .....</b>	<b>125</b>
Features of e-STUDIO Scan Editor .....	125
Application window .....	125
File window for the scanned images .....	130
Setting the preferences .....	133
<b>Scan to E-Mail .....</b>	<b>137</b>
Procedure for Scan to E-Mail.....	137
<b>Scan to File .....</b>	<b>140</b>
Procedure for Scan to File .....	140
<b>Scan to USB Memory.....</b>	<b>143</b>
Procedure for Scan to USB Memory.....	143
<b>Scan to Mobile.....</b>	<b>146</b>
Procedure for Scan to Mobile.....	146
<b>Scan Settings .....</b>	<b>149</b>
Selecting the color mode.....	149
Selecting the resolution .....	149
Scanning the 2-sided originals.....	150
Selecting the original size.....	150
Scanning different sizes in one go .....	151
Selecting the original mode .....	151
Selecting the orientation.....	152
Selecting the compression ratio .....	152
Removing blank pages .....	153
Adjusting the exposure.....	153
Continuing the scanning .....	154
Specifying E-mail Addresses .....	154
Character entry .....	158
Scan speed .....	159
<b>Using Templates (Scan) .....</b>	<b>161</b>
Registering the templates .....	161
Recalling a template .....	162

## Scanning From Application

This equipment supports scanning from TWAIN-compatible applications. TWAIN is the standard that links applications and scanners that acquire images. For TWAIN support, see your application's manual.

### Tip

You can make use of e-STUDIO Scan Editor bundled with the equipment. It helps you scan and edit images. For the details, refer to the following page:

📖 P.125 “Scanning from e-STUDIO Scan Editor”

Before you start scanning with this equipment, make sure that you have installed the scanner driver. For details, refer to the **Software Installation Guide**.

### Note

The default original size depends on the measurement system on Windows: A4 for Metric or LT for the North America. You can change the default only before the first execution after installation. For the measurement system, see the Windows Help.

📖 P.118 “How to scan”

## ■ How to scan

Follow the steps below to scan the original. The following describes a general scanning operation that is common to TWAIN-compatible applications.

### 1 Place the original(s).

📖 P.35 “Placing originals on the original glass”

📖 P.36 “Placing originals on the Reversing Automatic Document Feeder”

### 2 Run your TWAIN-compatible application and execute the image acquisition command.

You can usually execute the scan or image acquisition command on the [File] menu to select this equipment. The location of the command and the method to select the scanner vary depending on the application. See your application's manual.

### 3 Set the scan settings.

- You can make various options to scan the original image.  
📖 P.120 “Scan options”
- You can also make the scan settings using the Easy Set feature.  
📖 P.124 “Using the Easy Set feature”

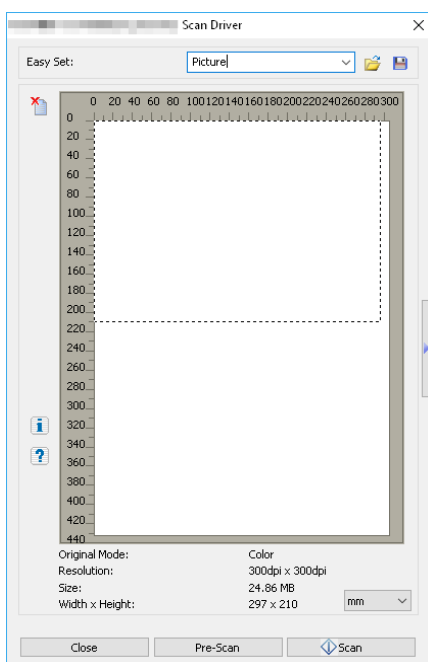

---

**4 Click [Pre-Scan] to preview the original.**

If you are not satisfied with the preview image, change the scan settings and preview the image again.

**5 Click [Scan] to scan the original.**

While scanning, you can stop scanning by clicking [CANCEL].

**Note**

When the authentication screen appears, enter the department code that is required to log in to this equipment. For details, ask your administrator.

**6 Save the scanned image in your application.**

The saving command varies depending on the application. You usually execute the Save or Save as command on the File menu. If necessary, modify the scanned image, using the various graphic commands in your application.

## Setting up Scan Options

You can make various options to affect the scanning status. You can save different sets of options in files and recall one of them for frequent use.

📖 P.120 “Scan options”

📖 P.123 “Scanning from the equipment on the network”

📖 P.123 “Scanning from the equipment connected by USB cable”

📖 P.124 “Using the Easy Set feature”

### ■ Scan options

The basic and advanced dialogs are available for the scan operation.

📖 P.120 “Basic scan dialog”

📖 P.121 “Advanced scan dialog”

### □ Basic scan dialog

When you execute the image acquisition command, the following basic scan dialog appears.

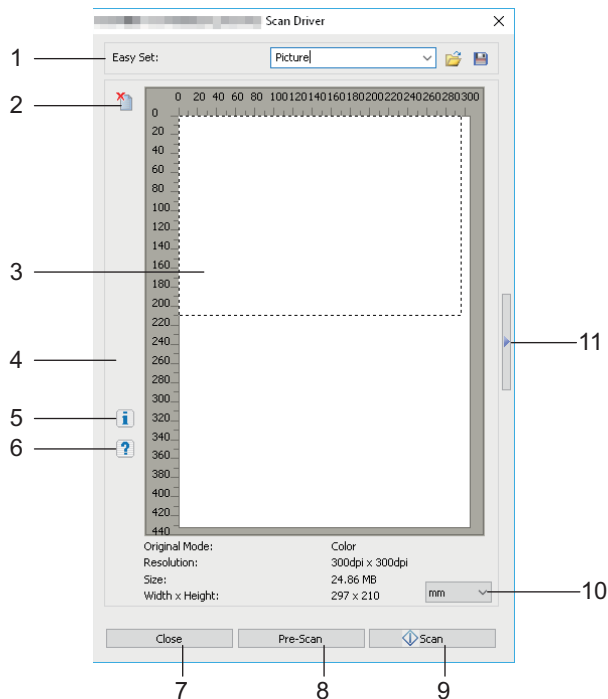

#### 1. Easy Set

The scan options can be saved.

📖 P.124 “Using the Easy Set feature”

#### 2.

Clears the preview image.

#### 3. Preview screen

The pre-scanned image appears. The dotted boundary shows the scanning area or the original size. The image information appears under the preview screen.

#### 4.

Opens the IO Type dialog to set the destination.





📖 P.123 “Scanning from the equipment on the network”

📖 P.123 “Scanning from the equipment connected by USB cable”

#### Tip

When you scan images using a TWAIN-compatible application, the Network-connected equipment takes a longer scan time than the USB-connected one, depending on the original and resolution.



5.  Shows the version information of the scanner driver.
6.  Shows the Help information about this scanner driver.
7. **[Close]**  
Quits the scanning operation.
8. **[Pre-Scan]**  
Pre-scans the original.
9. **[Scan]**  
Scans the original.
10. **Measurement unit**  
Select [Inch], [mm], or [Pixel] to change the measurement unit.
11.  Opens the advanced scan dialog.  
 P.121 “Advanced scan dialog”

## ❑ Advanced scan dialog

You can click the triangle that faces right on the right-hand side of the basic scan dialog box to make scanning settings. The default settings are underlined.

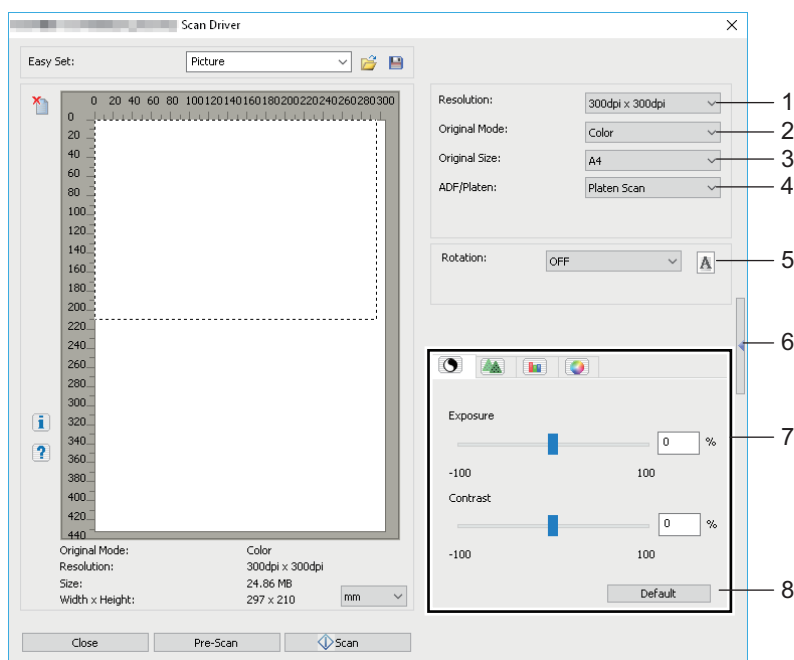

1. **Resolution**  
Sets the horizontal and vertical resolution as dots per inch: 150 x 150 dpi, 200 x 200 dpi, 300 x 300 dpi, 400 x 400 dpi, or 600 x 600 dpi.
2. **Original Mode**  
Sets the original mode to fit the original image such as text only or the mixture of text and photos: Text, Text/Photo, Gray, or Color.
3. **Original Size**  
Sets the original document size or the scanning area.  
Select the original size from the pull-down list.  
The displayed items differ depending on the installed options and destinations.

#### Tip

- When [600 x 600 dpi] is selected in [Resolution] and [Color] is selected in [Original Mode], only [A5-R] or [ST-R] can be selected.
- When [400 x 400 dpi] is selected in [Resolution] and [Color] is selected in [Original Mode], paper size larger than [A4] or [LT] cannot be selected.

#### 4. ADF/Platen

Selects the equipment on which the originals are placed: **Platen Scan**, ADF Scan, or Duplex Scan. The displayed items differ depending on the installed options and destinations.

#### 5. Rotation





Rotates the imaged clockwise by 90 degrees, counterclockwise by 90 degrees, or by 180 degrees. This option takes effect on the image to scan but not on the preview image: **OFF**, Right 90, Left 90, or 180.

#### 6.

Closes the advanced scan dialog and return to the basic scan dialog.

 P.120 "Basic scan dialog"

#### 7. [Enhanced Settings] tab

-  **Exposure/Contrast**  
Adjusts the exposure and contrast of the image using the scroll bar or editing the field: -100 (lighter) to 100% (darker).  
[Contrast] is only available when [Gray] or [Color] is selected in [Original Mode].
-  **Sharp**  
Adjusts the sharpness of the image using the scroll bar or editing the field: -2 (softer) to 3% (sharper).  
[Sharp] is only available when [Gray] or [Color] is selected in [Original Mode].
-  **RGB Adjustment**  
Adjusts the RGB values of the image using the scroll bar or editing the field: -100 to 100%.  
[RGB Adjustment] is only available when [Color] is selected in [Original Mode].
-  **Saturation**  
Adjusts the saturation of the image using the scroll bar or editing the field: -100 to 100%.  
[Saturation] is only available when [Color] is selected in [Original Mode].

#### 8. Default

Resets all the settings back to the defaults.

## ■ Scanning from the equipment on the network

- 1 Click  on the basic scan dialog box.
- 2 When the [IO Type] dialog box appears, select [IPv4] or [IPv6].

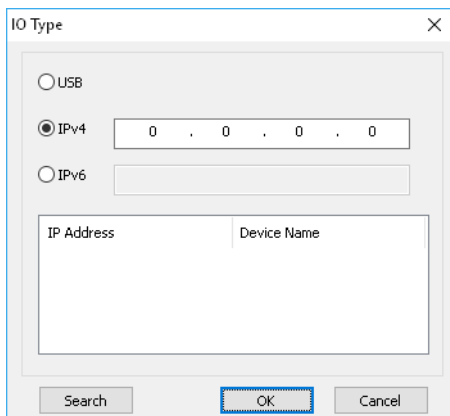

- 3 Click [Search], and then confirm the displayed IP address and device name.

### Tip

If you set the IP address manually, input the address in the text box.

- 4 Click [OK].

## ■ Scanning from the equipment connected by USB cable

- 1 Click  on the basic scan dialog box.
- 2 When the [IO Type] dialog box appears, select [USB].

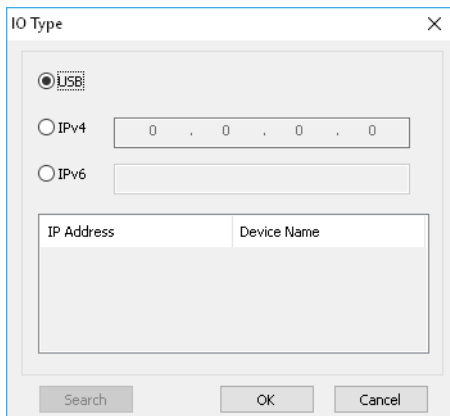

- 3 Click [OK].

---

## ■ Using the Easy Set feature

When you have made scan settings, you can save them as an Easy Set file. This allows you to load a specific batch of settings without changing the scan settings each time.

📖 P.124 “Saving the Easy Set file”

📖 P.124 “Using the Easy Set file”

📖 P.124 “Deleting the Easy Set files”

### ❑ Saving the Easy Set file

You can save multiple Easy Set files.

#### 1 Open the advanced scan dialog from within your application.

📖 P.118 “How to scan”

#### 2 Set the scan options as you like.

📖 P.120 “Scan options”

#### 3 Click next to the Easy Set menu.

#### 4 Enter a file name, select a folder where you save the file, and then click [Save].

### ❑ Using the Easy Set file

#### 1 Select the pre-defined Easy Set file, or click next to the Easy Set menu to select your Easy Set file.

- The following two pre-defined files are available.

Pre-defined File	Resolution	Original Mode	Other Scan Options
Picture	150 x 150 dpi	Text/Photo	Default settings
Text	600 x 600 dpi	Text	

- When the Open dialog box appears, select the folder, select the target Easy Set file, and then click [Open].

#### 2 Click [Pre-Scan].

### ❑ Deleting the Easy Set files

You can delete the Easy Set files in the same way as for normal files. Locate the folder where you have saved the Easy Set file, right-click the file, and then click [Delete] from the menu. Click [Yes] to delete the file. When you are working in the preview window, click the folder icon next to the Easy Set menu so that you can delete the file in the same way. After deleting the file, click [CANCEL] to close the dialog box.

## Scanning from e-STUDIO Scan Editor

e-STUDIO Scan Editor is an application to scan images with the equipment and edit them in Windows. From this application, you can use the scanner driver to scan images. When you have followed the standard steps to install the software such as a printer driver for the equipment, you also have installed this application. The following describes the functions of e-STUDIO Scan Editor.

For details about a scanning procedure, refer to the following page.

📖 P.118 “How to scan”

### ■ Features of e-STUDIO Scan Editor

e-STUDIO Scan Editor has the following features:

- Scan an image and save it in a PDF, TIFF, or JPEG format.
- Scan two or more images and save them in a PDF or TIFF format.
- Insert images in a file window, which are saved in a JPEG, BMP, TIFF, PNG, or PDF format.
- Arrange the images in a file window.
- Edit images simply within the application or open another application to edit them.
- Open the e-mail application that is available as standard in Windows and attach an image file to an e-mail.

### ■ Application window

You can start e-STUDIO Scan Editor from the [Start] menu of Windows. The following application window opens and a file window shows thumbnails or scanned images. You can also insert image files from a folder using a drag-and-drop operation. Select commands from the menu bar or click the icon on the tool bar to use this application.

📖 P.126 “Menu bar”

📖 P.128 “Tool bar”

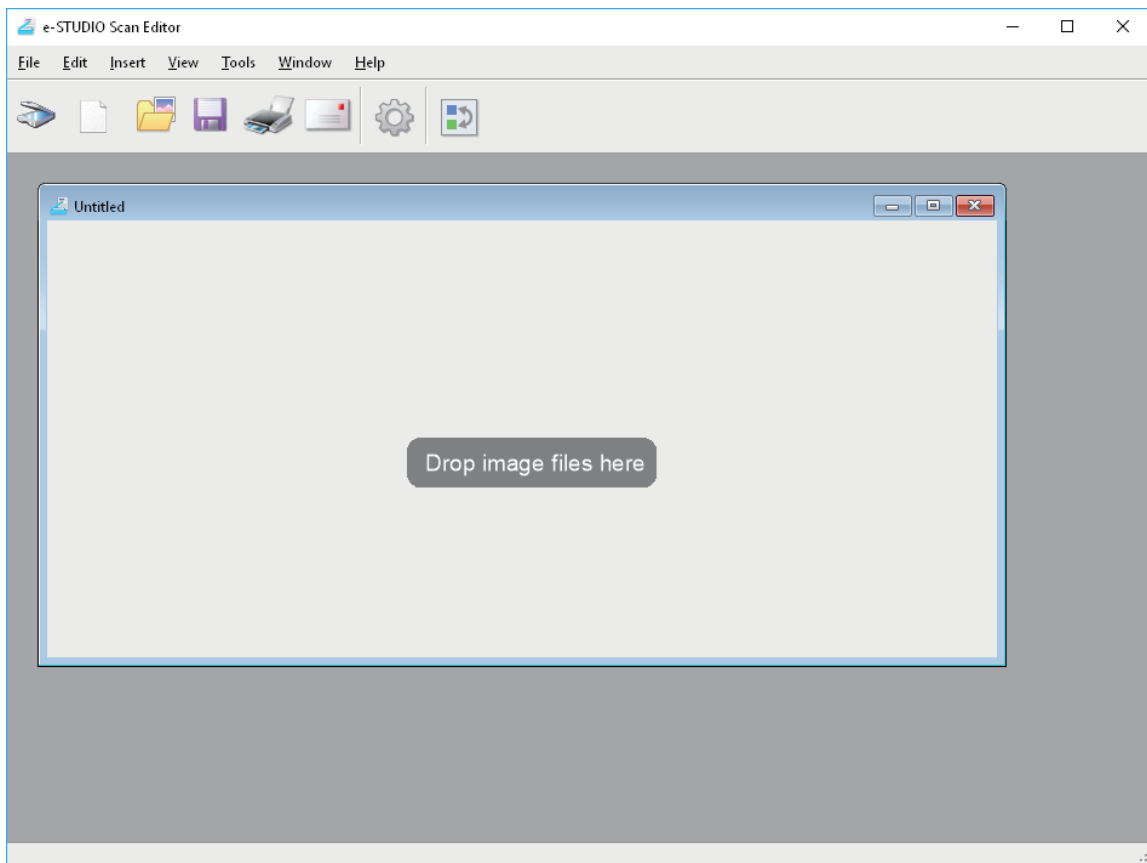

---

## ☐ Menu bar

The following menus are available on the menu bar located at the top of the application window. You can select commands from them.

- 📖 P.126 “[File] menu”
- 📖 P.127 “[Edit] menu”
- 📖 P.127 “[Insert] menu”
- 📖 P.127 “[View] menu”
- 📖 P.127 “[Tools] menu”
- 📖 P.128 “[Window] menu”
- 📖 P.128 “[Help] menu”

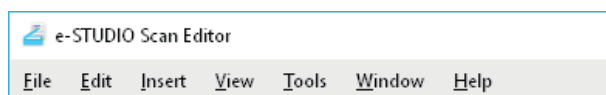

### [File] menu

You can select commands to handle files.

- **New**  
Opens a new file window.
- **Open**  
Opens files saved with this application or files saved in a JPEG, BMP, TIFF, PNG, or PDF format.
- **Close**  
Closes the selected file window.
- **Save**  
Saves a file. When you save a file first, you can name the file and save it in any folder. You can save a single image in a PDF, TIFF, or JPEG format and two or more images in a PDF or TIFF format.
- **Save As**  
Saves the selected file in another name. You can save a single image in a PDF, TIFF, or JPEG format and two or more images in a PDF or TIFF format.
- **Send**  
Opens the e-mail application that is available as standard in Windows and attaches the selected file to an e-mail. You can select a format (TIFF or PDF) of the attached file on [Send] of the [Preferences] dialog box.  
📖 P.135 “Send”
- **Print**  
Prints images in the selected file window.
- **Select Scanner**  
Selects the scanner (TWAIN source/driver) of the equipment. When a dialog box opens, you can select a TWAIN source in the list.

#### Tip

- The correct TWAIN source has been selected at the installation. In most cases, you do not need to select the scanner again.
- If one or more TWAIN sources have been installed, be sure to select the correct TWAIN source for the equipment.
- You can set preference for the TWAIN source on [Scanner] of the [Preferences] dialog box.  
📖 P.134 “Scanner”
- **Acquire**  
Opens the scanner driver to scan images. The scanned images are shown as thumbnails in a file window.  
📖 P.120 “Setting up Scan Options”
- **Exit**  
Quits this application.

## [Edit] menu

You can select common commands to handle images.

- **Undo**  
Undoes the last deleting operation.
- **Cut**  
Cuts the selected image.
- **Copy**  
Copy the selected image.
- **Paste**  
Pastes the cut or copied image at any position.
- **Delete Pages**  
Deletes the selected image.
- **Select All**  
Selects all images in a file window.

## [Insert] menu

You can select commands to insert images in a file window.

- **Insert**  
Insert images after the selected image or the last one, which are saved in a JPEG, BMP, TIFF, PNG, or PDF format.
- **Scanned Image**  
Scans images and inserts them after the selected image or the last one. You can scan images from the scanner driver.  
 P.120 "Setting up Scan Options"



## [View] menu

You can select commands to show or hide the tool bar and status bar.

- **Tool Bar**  
Shows or hides the tool bar at the top of the application window. You can turn on or off the tool bar by clicking the command to attach or remove a check mark.  
 P.128 "Tool bar"
- **Status Bar**  
Shows or hides the status bar at the bottom of the application window. You can turn on or off the tool bar by clicking the command to attach or remove a check mark.

## [Tools] menu

You can select commands to open the dialog box where you can arrange images in a file window or you can set the preferences for this application.

- **Arrange Pages**  
Opens the [Arrange Pages] dialog box to arrange the images in a file window.  
 P.132 "Arranging the images"
- **Preferences**  
Opens the [Preferences] dialog box to set the preferences for this application.  
 P.133 "Setting the preferences"

---

## [Window] menu

You can arrange the file windows in the application window.

- **Cascade**  
Arranges the file windows by cascading them.
- **Vertical**  
Arranges the file windows vertically.
- **Horizontal**  
Arranges the file windows horizontally.
- **Close All**  
Closes all file windows.
- **Arrange Icons**  
Minimizes and arranges the icons of file windows.

## [Help] menu

You can select the commands show the help or information window of this application.

- **Contents**  
Opens the help window of this application.
- **About**  
Open the information window of this application.

## ☐ Tool bar

The following tool icons are available on the tool bar located under the menu bar at the top of the application window.

Tip

You can show or hide the tool bar with [Too Bar] on the [View] menu.

📖 P.127 “[View] menu”

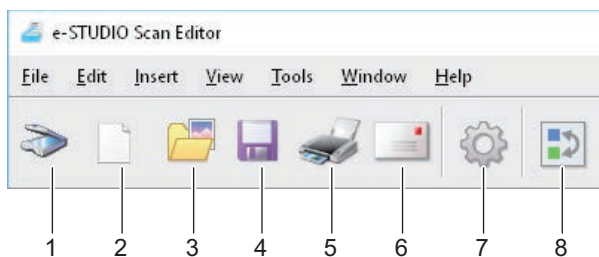

### 1. **Acquire**

Scans images. When you click this icon, the application starts scanning immediately or opens the scanner driver. You can set the action on [Scanner] of the [Preferences] dialog box.

📖 P.120 “Setting up Scan Options”

📖 P.134 “Scanner”

### 2. **New**

Opens a new file window.









### 3. **Open**

Opens files saved with this application or files saved in a JPEG, BMP, TIFF, PNG, or PDF format.

### 4. **Save**

Saves a file. When you save a file first, you can name the file and save it in any folder. You can save a single image in a PDF, TIFF, or JPEG format and two or more images in a PDF or TIFF format.



- 
5.  **Print**  
Prints images in the selected file window. When you click this icon, the application starts printing immediately or opens the print dialog box. You can set the action on [Printing] of the [Preferences] dialog box.  
 P.133 “Printing”
  6.  **Send**  
Attaches the selected file to an e-mail. You can select a format (TIFF or PDF) of the attached file on [Send] of the [Preferences] dialog box.  
 P.135 “Send”
  7.  **Preferences**  
Opens the [Preferences] dialog box to set the preferences for this application.  
 P.133 “Setting the preferences”
  8.  **Arrange Pages**  
Opens the [Arrange Pages] dialog box to arrange the images in a file window.  
 P.132 “Arranging the images”

## ■ File window for the scanned images

A scanned image appears as a thumbnail in a file window. When two or more images are scanned, all of them appear in a single file window. You can select a thumbnail and select commands from the shortcut menu, edit images, and arrange them in the file window.

📖 P.130 “Shortcut menu”

📖 P.131 “Editing an image”

📖 P.132 “Arranging the images”

### □ Shortcut menu

When you right-click a thumbnail, the shortcut menu appears so that you can select the following commands from the menu.

- **Cut, Copy, Paste, Delete**

Cuts, copies, and pastes an image. When you right-click a thumbnail and select [Cut] or [Copy] from the menu, you can cut or copy the selected image, then you can select [Paste] to paste it at any position. When you right-click a thumbnail and select [Delete] from the menu, you can delete the selected image.

- **Insert File**

Opens a dialog box so that you can select an image file to insert it in the current file window. You can insert images saved in a JPEG, BMP, TIFF, PNG, or PDF format.

Tip

- You can move image files to insert them into a file window using a drag-and-drop operation.
- You can insert an image also by selecting [Insert] from the [Insert] menu on the menu bar.

- **Insert Scanned Image**

Scans images and insert them in the current file window. When you select [Insert Scanned Image], the application starts scanning immediately or opens the scanner driver. You can set the action on [Scanner] of the [Preferences] dialog box.

📖 P.120 “Setting up Scan Options”

📖 P.134 “Scanner”

Tip



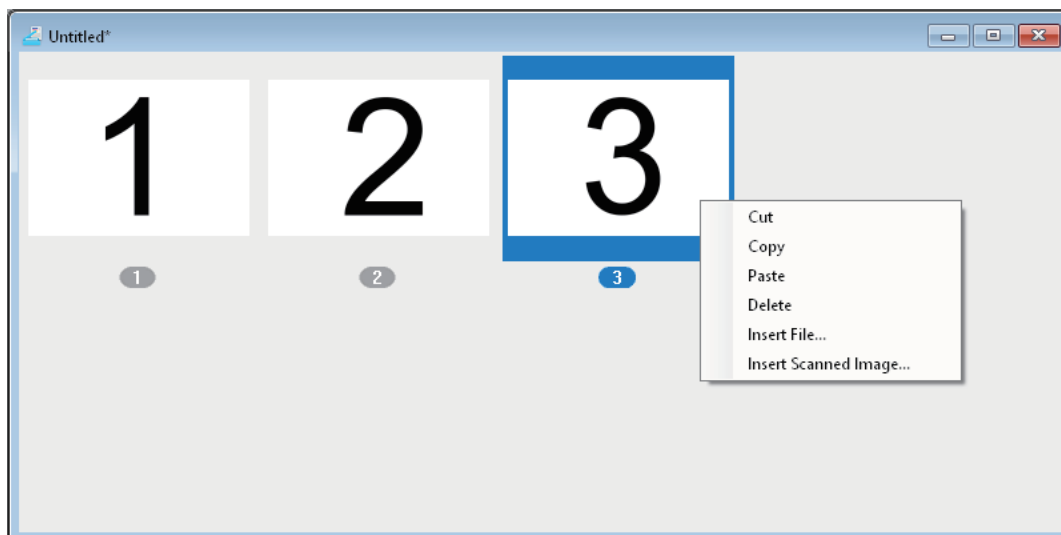



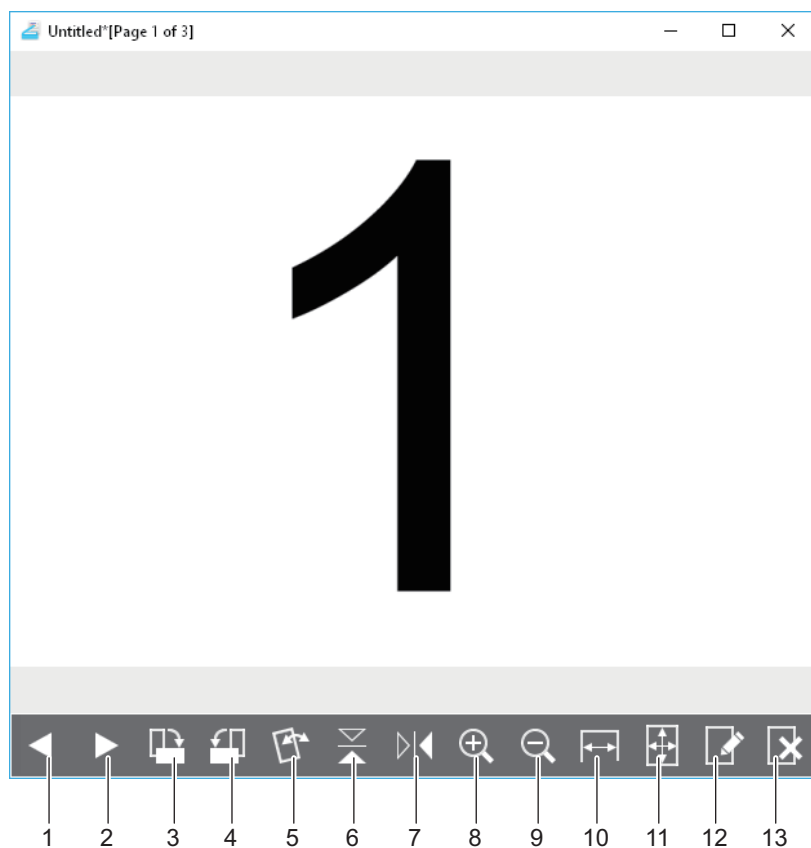

You can scan and insert images also by selecting [Scanned Image] from the [Insert] menu on the menu bar.



## ❑ Editing an image

When you double-click a thumbnail, an edit window opens. You can edit the image using the following icons at the bottom of the edit window. Click the [Previous Page] icon, the [Next Page] icon, or the Close button to save the edited image.



1.  **Previous Page**  
Shows the previous image in a file window.
2.  **Next Page**  
Shows the next image in a file window.
3.  **Rotate 90 degrees Clockwise**  
Rotates an image by 90 degrees clockwise.
4.  **Rotate 90 degrees Anti-Clockwise**  
Rotate an image 90 degrees anticlockwise
5.  **Tilt / Skew**  
Tilts a skewed image. You can select the action to confirm the operation or to execute it without confirmation on [Editor Options] of the [Preferences] dialog box.  
 P.136 “Editor Options”
6.  **Flip**  
Flips an image upside down.
7.  **Mirror**  
Inverts an image horizontally.

8.  **Zoom In**

Zooms in on an image.

9.  **Zoom Out**

Zooms out from an image.

10.  **Fit to Width**

Fits an image to the width of the window.

11.  **Best Fit**

Fits an image within the window.

12.  **Edit Page**

Opens an image in another application to edit it. You can select the application on [Editor Options] of the [Preferences] dialog box.

 P.136 “Editor Options”

**Tip**

By default, you can open images in “Paint” that is a standard application of Windows.

13.  **Delete Page**

Deletes the current image.

## Arranging the images

You can arrange images in two ways:

- Move a thumbnail to any position in a file window using a drag-and-drop operation.
- Select a file window and select [Arrange Pages] from the [Tools] menu. The [Arrange Pages] dialog box appears so that you can arrange images as follows:
  - Select an image and click [Move Up] to move it to the previous position.
  - Select an image and click [Move Down] to move it to the next position.
  - Select an image and click [Delete] to delete it.
  - Click [Reset] to cancel the operation you have done in this dialog box.
  - Click [OK] to complete the above operation and close this dialog box.
  - Click [Cancel] to cancel the above operation and close this dialog box.

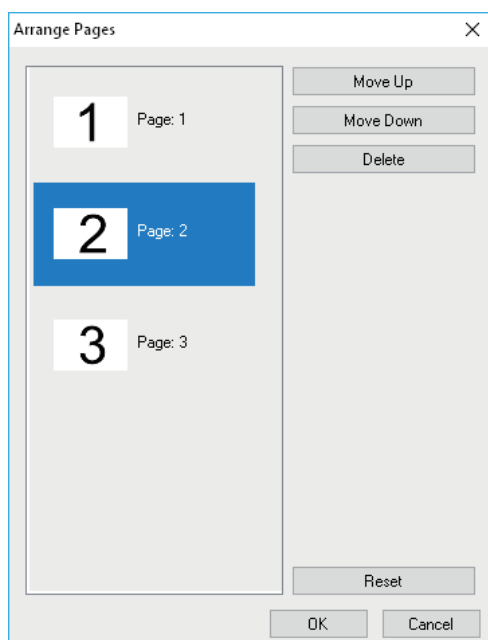

## ■ Setting the preferences

You can set the preferences to use the basic functions of e-STUDIO Scan Editor. Select [Preferences] from the [Tools] menu or click the [Preferences] icon on the too bar to open the [Preferences] dialog box. Click the icons at the top of the dialog box to set the following functions.

- 📖 P.133 “Printing”
- 📖 P.134 “Scanner”
- 📖 P.135 “Send”
- 📖 P.136 “Editor Options”

### □ Printing

You can set the following print functions on [Printing].

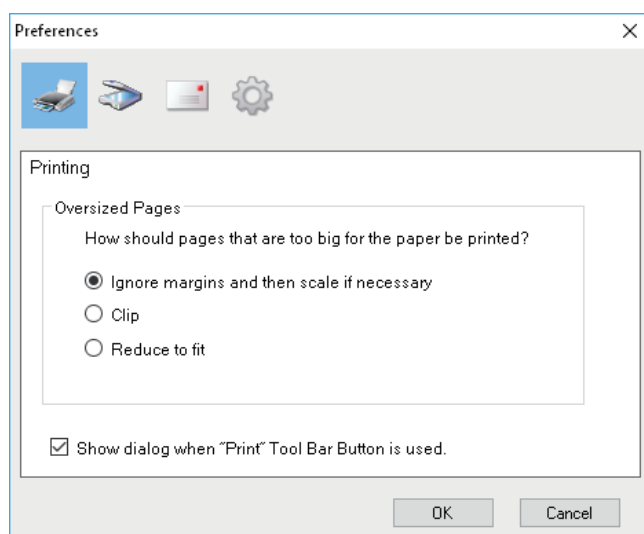

- **Oversized Pages**

Selects one of the following options to print pages that are too big for the paper.

  - **Ignore margins and then scale if necessary**

Ignores margins around an image and scale it to fit the paper if necessary.
  - **Clip**

Clips an image to print on the paper.
  - **Reduce to fit**

Reduces an image to print on the paper.
- **Show dialog when “Print” Tool Bar Button is used.**

Sets the action to be done when you click the [Print] icon on the tool bar. Select the check box to open the print dialog box. Click to clear the check box to start printing immediately without opening the print dialog box.

## Scanner

You can set the following scan functions on [Scanner].

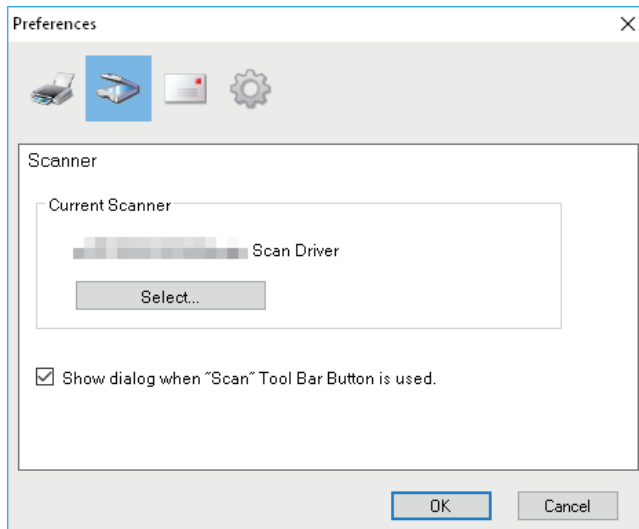

- **Current Scanner**

Shows the current scanner (TWAIN source/driver). When you click [Select], the dialog box opens so that you can select any one source from the list.

Tip

- The correct TWAIN source has been selected at the installation. In most cases, you do not need to select the scanner again.
  - If one or more TWAIN sources have been installed, be sure to select the correct TWAIN source for the equipment.
  - You can select a TWAIN source also by selecting [Select Scanner] from the [File] menu.
- **Show dialog when "Scan" Tool Bar Button is used.**  
Sets the action to be done when you click the [Acquire] icon on the tool bar or when you select [Insert Scanned Image] from the shortcut (or context) menu. Select the check box to open the scanner driver. Click to clear the check box to start scanning immediately without opening the scanner driver.

## □ Send

You can set the following e-mail functions on [Send].

### Note

This Send command is not available depending on the version of your Windows.

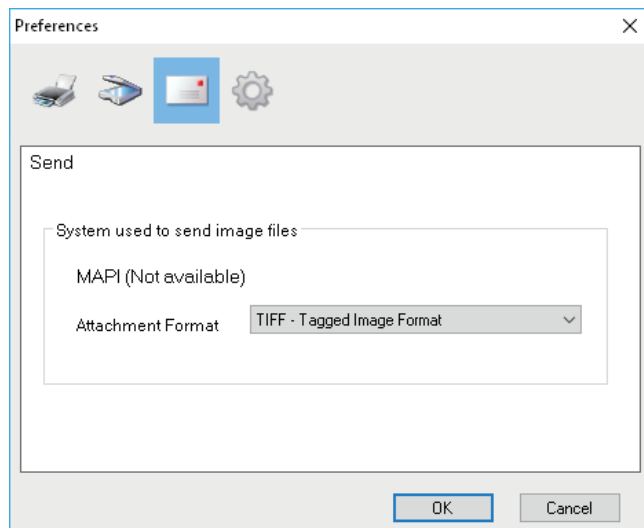

- **System used to send image files**

Shows an e-mail application. When you select [Send] from the [File] menu or click the [Send] icon on the tool bar, you can attach a file to an e-mail and send it with the selected application.

### Tip

The name of an e-mail application that has been set as a default program in Windows appears.

- **Attachment Format**

Selects a TIFF or PDF format of a file that you attach to an e-mail.

---

## ❑ Editor Options

You can set the following editor functions on [Editor Options].

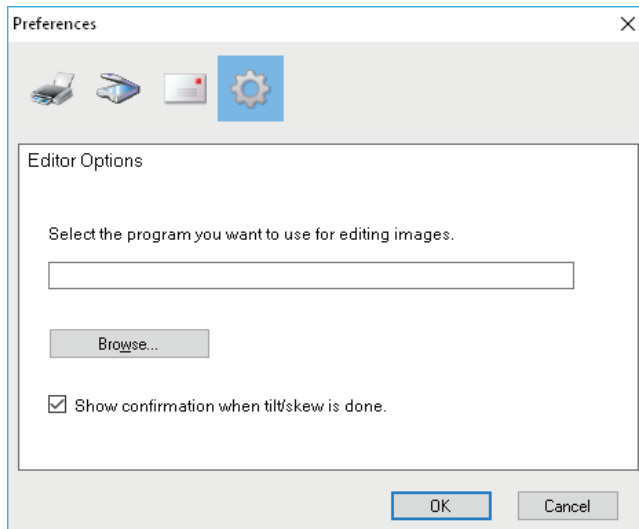

- **Select the program you want to use for editing images.**  
Shows an application to edit images. When you click [Browse], the dialog box opens so that you can select an application that you use to edit images. You can type a path of the application directly in the field. When you click the [Edit Page] icon in an edit window, you can open and edit the image within the selected application.
- **Show confirmation when tilt/skew is done.**  
Sets the action to be done when you click the [Tilt/Skew] icon in an edit window. Select the check box to show a confirmation message before tilting or skewing an image. Click to clear the check box to tilt or skew it immediately without confirmation.



## Scan to E-Mail

Scan to E-mail allows you to send your scans to specified e-mail addresses. The scanned image is converted to a PDF, TIFF, or JPEG file and sent as an e-mail attachment.

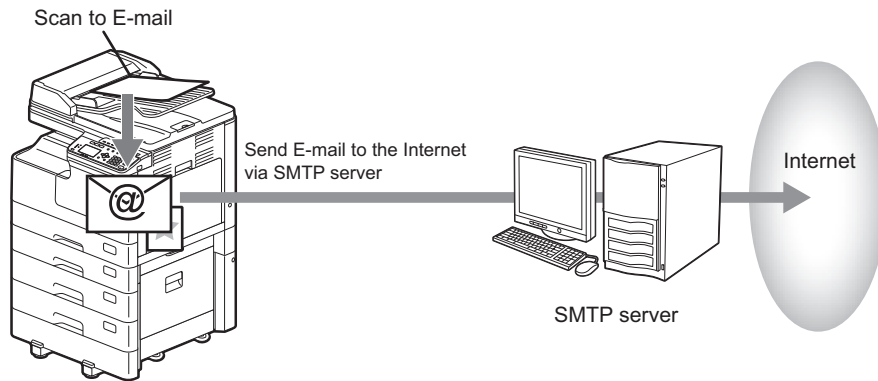

### ■ Procedure for Scan to E-Mail

#### 1 Place the original(s).

##### Tip

- For placing the originals, see the pages below.  
📖 P.35 “Copying originals”
  - When an original is set on the Reversing Automatic Document Feeder (RADF) for scanning, its size is automatically detected regardless of the settings specified in “ORIGINAL SIZE”.
  - The following originals can be scanned.
    - A/B format: A4, A3, A5-R, B5, B5-R, B4, A4-R and FOLIO\*
    - LT format: LT, LD, LT-R, LG, ST-R, COMP, 13"LG\* and 8.5"SQ\*
    - K format: 8K, 16K and 16K-R
- \*: Only when original is set on original glass.

#### 2 Press [SCAN].

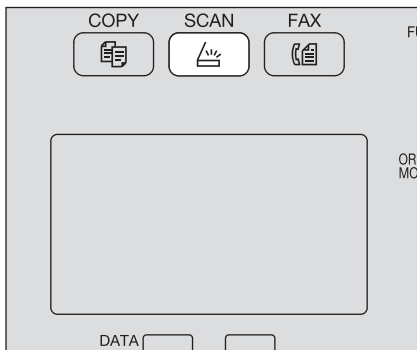

#### 3 Press $\nabla$ or $\triangle$ to select “E-MAIL”, and then press $\triangleright$ .

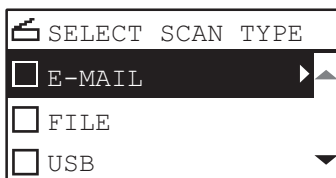

#### 4 Press $\nabla$ or $\triangle$ to select “ADDRESS”, and then press $\triangleright$ .

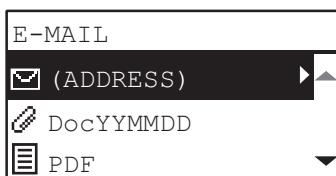

**5** Press  $\nabla$  or  $\triangle$  to select “TO (ADDRESS)” or “CC (ADDRESS)”, and then press  $\triangleright$ .



**6** Select from the Address Book or enter the address directly.

- P.154 “Specifying E-mail Addresses”
- P.158 “Character entry”

**7** Press  $\triangleleft$  to return to the E-MAIL screen.

**8** Press  $\nabla$  or  $\triangle$  to select the item, press  $\triangleright$ , and then make the scan settings as required.

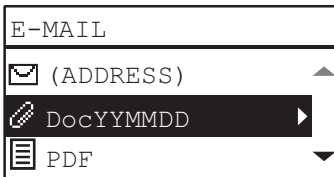

**Tip**

The settings available for Scan to E-Mail are as follows:

Menu Functions	Settings		Description
FILE NAME(MAX128)	-		An initial file name can be changed. P.158 “Character entry”
FILE FORMAT	PDF	MULTI	Stores your scan as a PDF file. Select [MULTI] for saving several pages as a single file. Select [SINGLE] for saving several pages as a separated single file for each page.
		SINGLE	
	TIFF	MULTI	Stores your scan as a TIFF file. Select [MULTI] for saving several pages as a single file. Select [SINGLE] for saving several pages as a separated single file for each page.
		SINGLE	
JPEG	Stores your scan as a JPEG file. This setting is not available when “BLACK” is selected in the “COLOR MODE” function.		
MESSAGE SIZE	NONE, 64, 128, 256, 512, 1024, 2048		Scans the data at the selected file size and sends them separately.

To make further settings, see the following.

- P.149 “Scan Settings”

**9** Press [START].

**10 If there are more originals, place the next ones.**

- When you place originals on the Reversing Automatic Document Feeder (RADF), select “SCAN NEXT” using ▾ or △ and press [OK]. (Only when “CONTINUE SCAN” is set to “ON”)
- When you place an original on the original glass, select “SCAN NEXT PAGE” using ▾ or △ and press [OK].



**Tip**

Repeat step 10 until all the originals have finished being scanned.

**11 If there are no more originals, select “FINISHED” using ▾ or △. The originals are stored by pressing the [OK].**

**Note**

If originals remain on the Reversing Automatic Document Feeder after pressing [FINISHED] on the CONTINUE SCAN screen, remove all the originals. Leaving them may cause a paper jam.

## Scan to File

Scan to File allows you to store scans as PDF, TIFF or JPEG files in a network folder. From these folders, you can copy the saved data and use it on your computer.

If you choose to store your scans in the network folder, the type of operating system, such as Windows or Macintosh, does not matter; you can save the data in any network folder accessible by FTP or SMB.

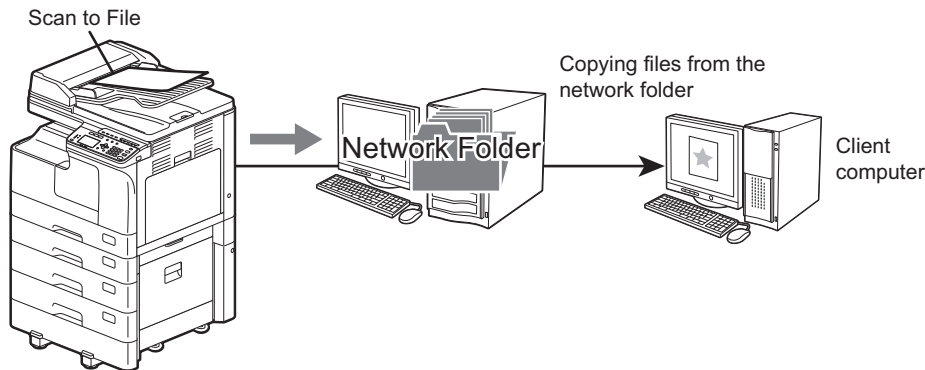

### ■ Procedure for Scan to File

#### Note

- The network administrator has to make settings for storing the scanned data to the client computers. For details, refer to the **TopAccess Guide**.
- We recommend that you back up the data stored in the shared folder.
- Delete documents stored in the shared folder when they are no longer needed.

#### 1 Place the original(s).

##### Tip

- For placing the originals, see the pages below.  
📖 P.35 “Copying originals”
  - When an original is set on the Reversing Automatic Document Feeder (RADF) for scanning, its size is automatically detected regardless of the settings specified in “ORIGINAL SIZE”.
  - The following originals can be scanned.
    - A/B format: A4, A3, A5-R, B5, B5-R, B4, A4-R and FOLIO\*
    - LT format: LT, LD, LT-R, LG, ST-R, COMP, 13"LG\* and 8.5"SQ\*
    - K format: 8K, 16K and 16K-R
- \* : Only when original is set on original glass.

#### 2 Press [SCAN].

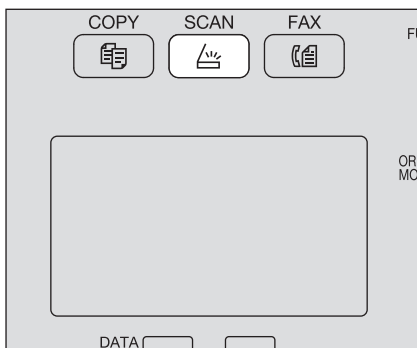

**3** Press  $\nabla$  or  $\triangle$  to select “FILE”, and then press  $\triangleright$ .

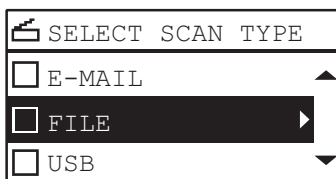

**4** Press  $\nabla$  or  $\triangle$  to select “REMOTE1” or “REMOTE2”, and then press  $\triangleright$ .

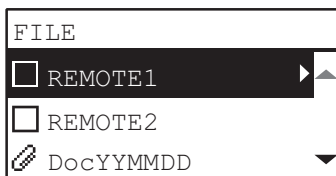

**5** Press  $\nabla$  or  $\triangle$  to select the item, press  $\triangleright$ , and then make the scan settings as required.

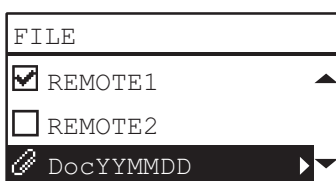

Tip

The settings available for Scan to FILE are as follows:

Menu Functions	Settings		Description	
<b>FILE NAME(MAX128)</b>	-		An initial file name can be changed. 📖 P.158 “Character entry”	
<b>FILE FORMAT</b>	<b>PDF</b>	<b>MULTI</b>	Stores your scan as a PDF file. Select [MULTI] for saving several pages as a single file. Select [SINGLE] for saving several pages as a separated single file for each page.	
		<b>SINGLE</b>		
	<b>TIFF</b>	<b>MULTI</b>		Stores your scan as a TIFF file. Select [MULTI] for saving several pages as a single file. Select [SINGLE] for saving several pages as a separated single file for each page.
		<b>SINGLE</b>		
	<b>JPEG</b>		Stores your scan as a JPEG file. This setting is not available when “BLACK” is selected in the “COLOR MODE” function.	

To make further settings, see the following.

📖 P.149 “Scan Settings”

**6** Press [START].

---

## 7 If there are more originals, place the next ones.

- When you place originals on the Reversing Automatic Document Feeder (RADF), select “SCAN NEXT” using ▾ or △ and press [OK]. (Only when “CONTINUE SCAN” is set to “ON”)
- When you place an original on the original glass, select “SCAN NEXT PAGE” using ▾ or △ and press [OK].

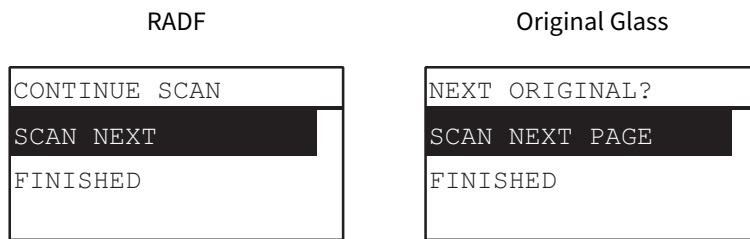

### Tip

Repeat step 7 until all the originals have finished being scanned.

## 8 If there are no more originals, select “FINISHED” using ▾ or △. The originals are stored by pressing the [OK].

### Note

If originals remain on the Reversing Automatic Document Feeder after pressing [FINISHED] on the CONTINUE SCAN screen, remove all the originals. Leaving them may cause a paper jam.

## Scan to USB Memory

Scan to USB allows you to save scanned images as PDF, TIFF, or JPEG files in a USB storage device.

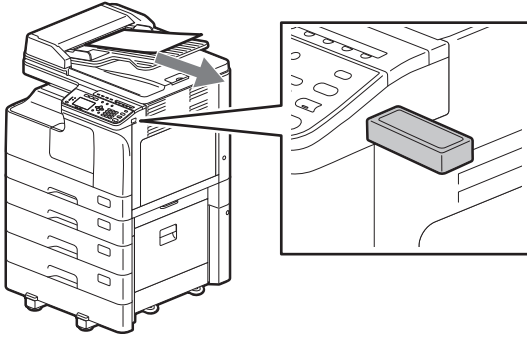

### ■ Procedure for Scan to USB Memory

#### Note

USB storage devices must meet requirements below. However, some USB storage devices may not be used with this equipment even though the requirements below are met.

- FAT16 or FAT32 format
- Single-partition (USB storage devices with multiple partitions are not supported.)

#### 1 Place the original(s).

##### Tip

- For placing the originals, see the pages below.  
📖 P.35 “Copying originals”
  - When an original is set on the Reversing Automatic Document Feeder (RADF) for scanning, its size is automatically detected regardless of the settings specified in “ORIGINAL SIZE”.
  - The following originals can be scanned.
    - A/B format: A4, A3, A5-R, B5, B5-R, B4, A4-R and FOLIO\*
    - LT format: LT, LD, LT-R, LG, ST-R, COMP, 13"LG\* and 8.5"SQ\*
    - K format: 8K, 16K and 16K-R
- \* Only when original is set on original glass.

#### 2 Press [SCAN].

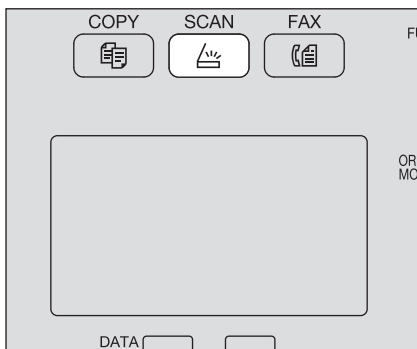

- 3 To store scans in a USB storage device, connect the device to the equipment and wait a few seconds.**

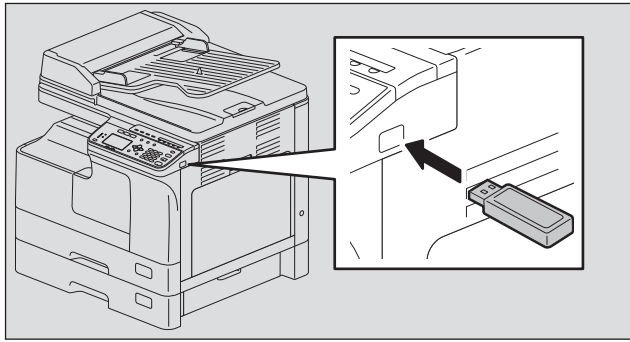

- 4 Press  $\nabla$  or  $\triangle$  to select “USB”, and then press [OK].**

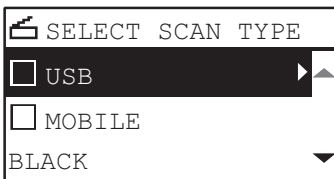

- 5 Press  $\triangleright$ , and then make the scan settings as required.**

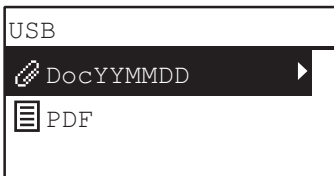

**Tip**

The settings available for Scan to USB Memory are as follows:

Menu Functions	Settings		Description
<b>FILE NAME(MAX128)</b>	-		An initial file name can be changed. 📖 P.158 “Character entry”
<b>FILE FORMAT</b>	<b>PDF</b>	<b>MULTI</b>	Stores your scan as a PDF file. Select [MULTI] for saving several pages as a single file. Select [SINGLE] for saving several pages as a separated single file for each page.
		<b>SINGLE</b>	
	<b>TIFF</b>	<b>MULTI</b>	Stores your scan as a TIFF file. Select [MULTI] for saving several pages as a single file. Select [SINGLE] for saving several pages as a separated single file for each page.
		<b>SINGLE</b>	
	<b>JPEG</b>		Stores your scan as a JPEG file. This setting is not available when “BLACK” is selected in the “COLOR MODE” function.

To make further settings, see the following.  
📖 P.149 “Scan Settings”



## 6 Press [START].

### Note

When you store scans in a USB storage device, never attempt to remove the device from the equipment until data transmission is completed. Removing the USB storage device during data transmission may corrupt the device.

## 7 If there are more originals, place the next ones.

- When you place originals on the Reversing Automatic Document Feeder (RADF), select “SCAN NEXT” using  $\nabla$  or  $\triangle$  and press [OK]. (Only when “CONTINUE SCAN” is set to “ON”)
- When you place an original on the original glass, select “SCAN NEXT PAGE” using  $\nabla$  or  $\triangle$  and press [OK].

RADF

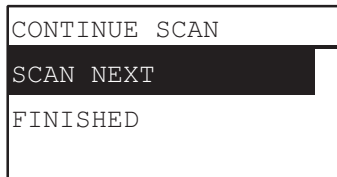

Original Glass

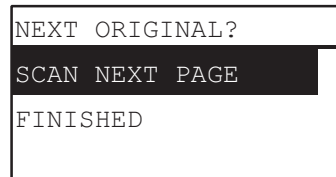

### Tip

Repeat step 7 until all the originals have finished being scanned.

## 8 If there are no more originals, select “FINISHED” using $\nabla$ or $\triangle$ . The originals are stored by pressing the [OK].

### Note

If originals remain on the Reversing Automatic Document Feeder after pressing [FINISHED] on the CONTINUE SCAN screen, remove all the originals. Leaving them may cause a paper jam.

## Scan to Mobile

Scan to Mobile allows you to save scanned images as PDF, TIFF, or JPEG files in an Android device connected with a USB cable.

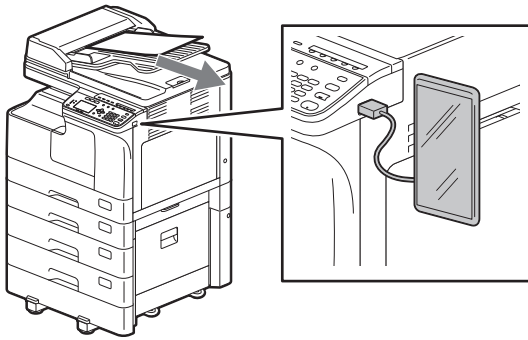

### ■ Procedure for Scan to Mobile

#### Note

- Scan to Mobile function is available on an Android device with OS 7 or later.
- Set the USB connection mode of the Android device to connect as a media device (MTP).

#### 1 Place the original(s).

##### Tip

- For placing the originals, see the pages below.  
📖 P.35 “Copying originals”
  - When an original is set on the Reversing Automatic Document Feeder (RADF) for scanning, its size is automatically detected regardless of the settings specified in “ORIGINAL SIZE”.
  - The following originals can be scanned.
    - A/B format: A4, A3, A5-R, B5, B5-R, B4, A4-R and FOLIO\*
    - LT format: LT, LD, LT-R, LG, ST-R, COMP, 13"LG\* and 8.5"SQ\*
    - K format: 8K, 16K and 16K-R
- \* Only when original is set on original glass.

#### 2 Press [SCAN].

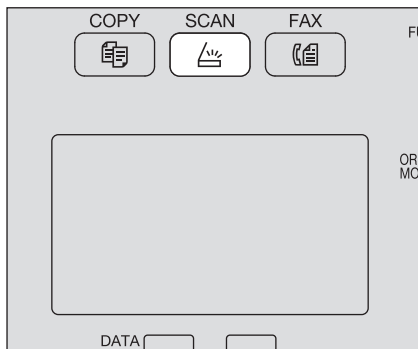

#### 3 To store scans in an Android device, connect it to the equipment and wait a few seconds.

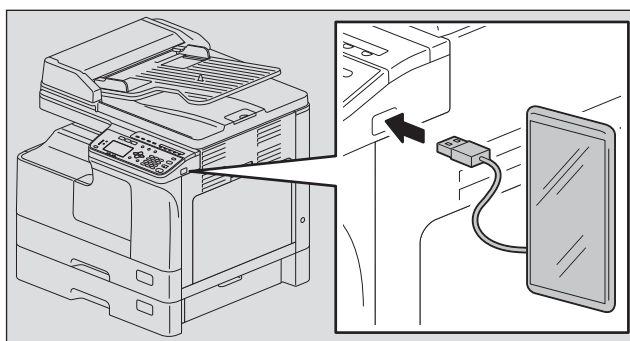

#### 4 Press $\nabla$ or $\triangle$ to select “MOBILE”, and then press [OK].

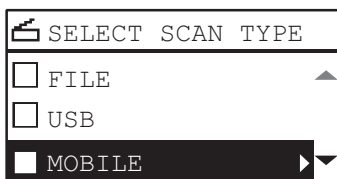

#### 5 Press $\triangleright$ , and then select the folder to store the scans.

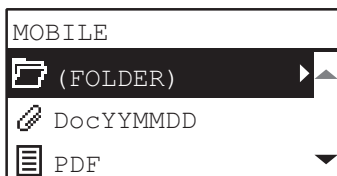

#### 6 Make the scan settings as required.

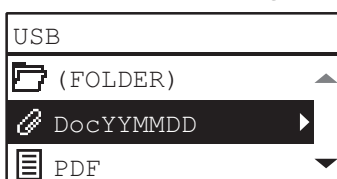

#### Tip

The settings available for Scan to Mobile are as follows:

Menu Functions	Settings		Description
FILE NAME(MAX128)	-		An initial file name can be changed. P.158 “Character entry”
FILE FORMAT	PDF	MULTI	Stores your scan as a PDF file. Select [MULTI] for saving several pages as a single file. Select [SINGLE] for saving several pages as a separated single file for each page.
		SINGLE	
	TIFF	MULTI	Stores your scan as a TIFF file. Select [MULTI] for saving several pages as a single file. Select [SINGLE] for saving several pages as a separated single file for each page.
		SINGLE	
	JPEG		Stores your scan as a JPEG file. This setting is not available when “BLACK” is selected in the “COLOR MODE” function.

To make further settings, see the following.

P.149 “Scan Settings”

#### 7 Press [START].

#### Note

When you store the scans in an Android device, never attempt to disconnect it from the equipment until data transmission is completed. Disconnecting the Android device during data transmission may corrupt it.

---

## 8 If there are more originals, place the next ones.

- When you place originals on the Reversing Automatic Document Feeder (RADF), select “SCAN NEXT” using ▾ or △ and press [OK]. (Only when “CONTINUE SCAN” is set to “ON”)
- When you place an original on the original glass, select “SCAN NEXT PAGE” using ▾ or △ and press [OK].

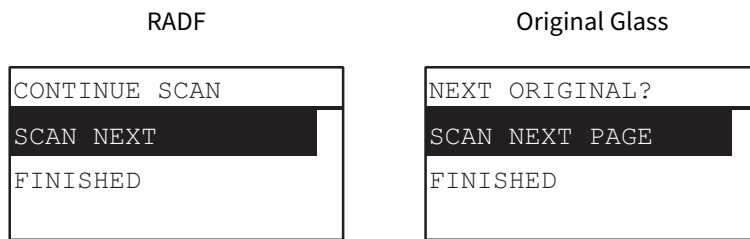

### Tip

Repeat step 8 until all the originals have finished being scanned.

## 9 If there are no more originals, select “FINISHED” using ▾ or △. The originals are stored by pressing the [OK].

### Note

If originals remain on the Reversing Automatic Document Feeder after pressing [FINISHED] on the CONTINUE SCAN screen, remove all the originals. Leaving them may cause a paper jam.

## Scan Settings

You can make the scan settings on the scan functions menu.

### Tip

Press [CANCEL] to exit from the setting without making any changes. You can also exit by pressing ◀ if it is active.

### ■ Selecting the color mode

You can select the color mode best suited to your scan job.

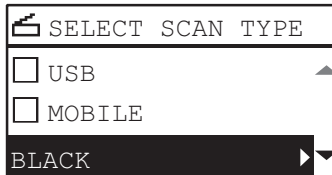

Menu Functions	Settings	Description
COLOR MODE	BLACK	Images in black and white.
	GRAY SCALE	Images containing both text and photos. The photo quality is enhanced.
	FULL COLOR	Color images.

- 1 Press [SCAN].
- 2 Press ▾ or ▲ to select the item displayed on the LCD screen, and then press ▷.
- 3 Press ▾ or ▲ to select the setting item, and then press [OK].

### ■ Selecting the resolution

You can select the resolution.

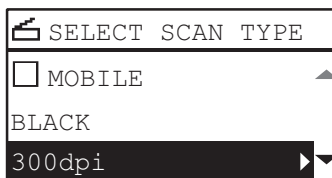

Menu Functions	Settings
RESOLUTION	600dpi <sup>*1</sup>
	400dpi <sup>*2</sup>
	300dpi
	200dpi
	150dpi

\*1 When the "FULL COLOR" mode has been selected, you can select "600 dpi" only for the original of A5-R or ST-R size.

\*2 When the "FULL COLOR" mode has been selected, you cannot select the original size larger than A4 or LT.

- 1 Press [SCAN].
- 2 Press ▾ or ▲ to select the item displayed on the LCD screen, and then press ▷.
- 3 Press ▾ or ▲ to select the setting item, and then press [OK].

## ■ Scanning the 2-sided originals

With the single/2-sided scan setting, you can choose whether to scan your originals on both sides.

### Note

To scan 2-sided originals automatically, the Reversing Automatic Document Feeder is required.

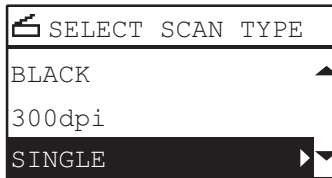

Menu Functions	Settings	Description
SINGLE/2-SIDED SCAN	SINGLE	Scans only the front of the originals.
	DUPLEX	Scans both sides of the originals.

- 1 Press [SCAN].
- 2 Press  $\nabla$  or  $\triangle$  to select the item displayed on the LCD screen, and then press  $\triangleright$ .
- 3 Press  $\nabla$  or  $\triangle$  to select the setting item, and then press [OK].

## ■ Selecting the original size

You can specify the original size.



Menu Functions	Settings	Description
ORIGINAL SIZE	AUTO SIZES	Detects the size of your originals.
	A3, A4, A4-R, A5-R, B4, B5, B5-R, FOLIO, 8K, 16K, 16KR, LD, LG, LT, LT-R, COMP, 13"LG, ST-R, 8.5"SQ	Sets the size of your originals.

- 1 Press [SCAN].
- 2 Press  $\nabla$  or  $\triangle$  to select the item displayed on the LCD screen, and then press  $\triangleright$ .
- 3 Press  $\nabla$  or  $\triangle$  to select the setting item, and then press [OK].

### Tip

When an original is set on the Reversing Automatic Document Feeder (RADF) for scanning, its size is automatically detected regardless of the settings specified in "ORIGINAL SIZE".

## ■ Scanning different sizes in one go

When different sizes of originals are mixed and placed on the Reversing Automatic Document Feeder, some combinations of sizes can be scanned in one go.

The combination of the original sizes that can be mixed are as follows:

Other than North America: A3 and A4 or B4 and B5

North America: LD and LT or LG and LT-R



Menu Functions	Settings
MIXED SIZE ORIGINAL	OFF
	ON

- 1** Press [SCAN].
- 2** Press ▾ or ▲ to select the item displayed on the LCD screen, and then press ▷.
- 3** Press ▾ or ▲ to select the setting item, and then press [OK].

## ■ Selecting the original mode

You can select the original mode for the image quality best suited to your originals.



Menu Functions	Settings	Description
ORIGINAL MODE	TEXT/PHOTO	Text and photographs mixed.
	TEXT	Scans in the appropriate image quality for the original(s) with text, fine illustration and watermark.
	PHOTO	Photographs only.

- 1** Press [SCAN].
- 2** Press ▾ or ▲ to select the item displayed on the LCD screen, and then press ▷.
- 3** Press ▾ or ▲ to select the setting item, and then press [OK].

## ■ Selecting the orientation

You can change the orientation of your scans. Select the desired rotation pattern.



Menu Functions	Settings	Description
<b>ROTATION</b>		Scans originals without a change in orientation.
		Rotates your scans 90 degrees to the right.

- 1** Press [SCAN].
- 2** Press ▾ or ▲ to select the item displayed on the LCD screen, and then press ▷.
- 3** Press ▾ or ▲ to select the setting item, and then press [OK].

### Note

This option is available only when the file format is PDF. When the file format is TIFF or JPEG, scanning is performed by means of (rotating scans 90 degrees to the right).

## ■ Selecting the compression ratio

You can select the compression ratio for the scanned image data. In general, the higher the compression ratio, the lower the image quality.



### Note

This function is not available when “BLACK” is selected in the “COLOR MODE” function.

Menu Functions	Settings	Description
<b>COMPRESS</b>	<b>LOW</b>	Applies a low compression ratio and enhances the image quality.
	<b>MID</b>	Compresses the data with a moderate compression ratio and obtains an average image quality.
	<b>HIGH</b>	For a high compression ratio. Suitable when you want to minimize the data size rather than enhance the image quality.

- 1** Press [SCAN].
- 2** Press ▾ or ▲ to select the item displayed on the LCD screen, and then press ▷.
- 3** Press ▾ or ▲ to select the setting item, and then press [OK].



## ■ Removing blank pages

If your original contains blank pages, you can remove them from the scan result.

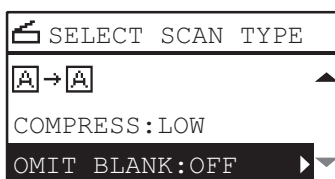

### Note

This function is available only when “BLACK” is selected in the “COLOR MODE” function.

Menu Functions	Settings
OMIT BLANK PAGE	OFF
	ON

- 1 Press [SCAN].
- 2 Press  $\nabla$  or  $\triangle$  to select the item displayed on the LCD screen, and then press  $\triangleright$ .
- 3 Press  $\nabla$  or  $\triangle$  to select the setting item, and then press [OK].

## ■ Adjusting the exposure

You can adjust the density to make scans lighter or darker in nine levels from -4 to +4. The auto density setting can represent the scan image in the middle density status.

### Note

- This function is not available when “GRAY SCALE” is selected in the “COLOR MODE” function.
- “AUTO” is available only when “BLACK” is selected in the “COLOR MODE” function and “TEXT” or “TEXT/PHOTO” is selected in the “ORIGINAL MODE” function.

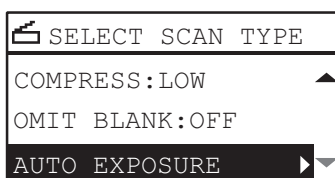

Menu Functions	Settings	Description
EXPOSURE	AUTO	Adjusts the density automatically.
	Manual	Adjusts the density manually.

- 1 Press [SCAN].
- 2 Press  $\nabla$  or  $\triangle$  to select the item displayed on the LCD screen, and then press  $\triangleright$ .
- 3 Press  $\nabla$  or  $\triangle$  to select the setting item.
- 4 Adjust the density as follows.
  - For “AUTO”:**  
Press [OK].
  - For manual:**
    1. Press  $\triangleright$  or  $\triangleleft$  to increase or decrease the density level.
    2. Press [OK].

## ■ Continuing the scanning

When you scan with the Reversing Automatic Document Feeder (RADF), you can select whether you continue scanning the next originals after the last loaded original is scanned.

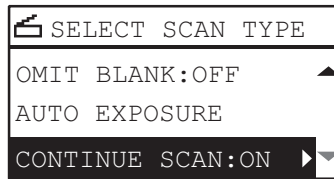

Menu Functions	Settings
CONTINUE SCAN	OFF
	ON

- 1 Press [SCAN].
- 2 Press  $\nabla$  or  $\triangle$  to select the item displayed on the LCD screen, and then press  $\triangleright$ .
- 3 Press  $\nabla$  or  $\triangle$  to select the setting item, and then press [OK].

## ■ Specifying E-mail Addresses

To specify e-mail addresses for the Scan to E-mail function, you have the following options:

### Tip

Up to 220 addresses can be specified.

- 📖 P.154 “Entering an e-mail Addresses”
- 📖 P.155 “Selecting from the address book”
- 📖 P.155 “Searching the address book with single numbers”
- 📖 P.156 “Searching the address book with group numbers”
- 📖 P.157 “Viewing/Deleting specified e-mail addresses”

## □ Entering an e-mail Addresses

- 1 Press  $\nabla$  or  $\triangle$  to select “INPUT ADDRESS”, and then press  $\triangleright$ .

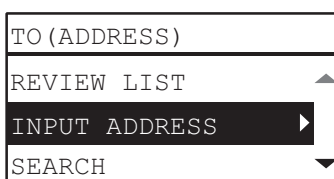

- 2 Enter an e-mail address using the digital keys.



- 📖 P.158 “Character entry”

- 3 Press [OK].

### Tip

- You can enter up to 220 addresses in total for “TO (ADDRESS)” and “CC (ADDRESS)”.
- If you want to view or delete the specified e-mail addresses, see the following page.
  - 📖 P.157 “Viewing/Deleting specified e-mail addresses”

## ❑ Selecting from the address book

**1** Press  $\nabla$  or  $\triangle$  to select “SEARCH”, and then press  $\triangleright$ .

TO (ADDRESS)
REVIEW LIST
INPUT ADDRESS
SEARCH

**2** Using  $\triangleright$  or  $\triangleleft$ , select letters tab that you want to display. Using  $\nabla$  or  $\triangle$ , select the desired contact, and then press [OK].

$\triangleleft$ ALL	A-Z	0-9	ABC	$\triangleright$
$\otimes$ 001test1				
$\otimes$ 002test2				
$\otimes$ abc				

**3** Press [OK].

### Tip

- You can enter up to 220 addresses in total for “TO (ADDRESS)” and “CC (ADDRESS)”.
- If you want to view or delete the specified e-mail addresses, see the following page.  
 P.157 “Viewing/Deleting specified e-mail addresses”

## ❑ Searching the address book with single numbers

**1** Press  $\nabla$  or  $\triangle$  to select “SINGLE NUMBER”, and then press  $\triangleright$ .

TO (ADDRESS)
INPUT ADDRESS
SEARCH
SINGLE NUMBER

**2** Using the digital keys, enter the single number for the desired contact.

TO: ADDRESS
SINGLE (001-200)
120

**3** Press [OK].

### Tip

- You can enter up to 220 addresses in total for “TO (ADDRESS)” and “CC (ADDRESS)”.
- If you want to view or delete the specified e-mail addresses, see the following page.  
 P.157 “Viewing/Deleting specified e-mail addresses”

---

## ❑ Searching the address book with group numbers

**1** Press  $\nabla$  or  $\triangle$  to select “GROUP NUMBER”, and then press  $\triangleright$ .

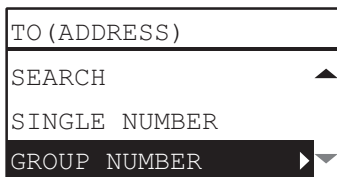

TO (ADDRESS)  
SEARCH  
SINGLE NUMBER  
GROUP NUMBER

**2** Using the digital keys, enter the group number for the desired contact.

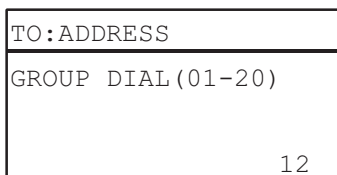

TO: ADDRESS  
GROUP DIAL (01-20)  
12

**3** Press [OK].

Tip

- You can enter up to 220 addresses in total for “TO (ADDRESS)” and “CC (ADDRESS)”.
- If you want to view or delete the specified e-mail addresses, see the following page.  
 P.157 “Viewing/Deleting specified e-mail addresses”

## □ Viewing/Deleting specified e-mail addresses

You can view the specified e-mail addresses, contacts, and groups, and delete them from the list.

- 1 On the “E-MAIL ADDRESS” menu, select “TO” or “CC” using  $\nabla$  or  $\triangle$ , and then press  $\triangleright$ .**  
If you select “CC”, select “REVIEW LIST” using  $\nabla$  or  $\triangle$ , and then press [OK].

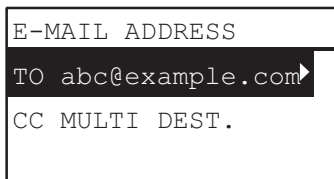

Currently selected e-mail addresses, contacts, and groups are listed on the screen. To delete an e-mail address, contact, and/or group from the list, go to step 2.

- 2 Select a listing you want to delete, and then press [CLEAR/STOP].**

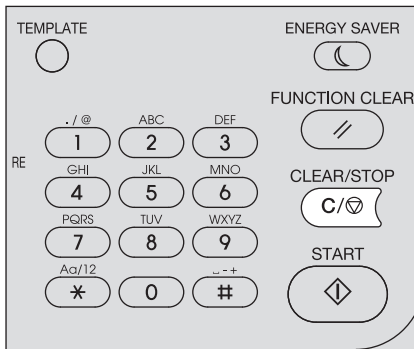

- 3 “DELETE DESTINATION?” message appears, select “YES” using  $\nabla$  or  $\triangle$ , and then press [OK].**

## ■ Character entry

The character entry screen is for entering characters when you are setting and entering items.

You can enter the following:

Alphabet characters, numbers and symbols.

Enter the characters using the digital keys and  $\triangle$ ,  $\nabla$ ,  $\triangleright$ , or  $\triangleleft$ , after switching the type of the character with the [\*] digital key.

### □ Switching the input mode

The type of the character is displayed in the first line of the message display panel. Set the type of character to enter by pressing the [\*] digital key.

The input mode switches as follows each time the [\*] key is pressed.

**Alphabet characters <--> Numbers**

### □ Entering characters

Example: To enter “Chicago”

#### 1 Press [\*] to set the alphabet input mode.

FILE NAME (MAX128)
—
$\frac{00}{01}$ : Aa

#### 2 Press [2] a few times to enter “C”.

FILE NAME (MAX128)
C
$\frac{00}{01}$ : Aa

#### 3 Press $\triangleright$ to move the cursor to the right.

FILE NAME (MAX128)
C_
$\frac{00}{01}$ : Aa

#### Tip

If you want to enter the character assigned to another digital key, you can enter it without moving the cursor to the right or pressing  $\triangleright$ .

#### 4 Similarly, you can enter the following characters using the digital keys.

FILE NAME (MAX128)
Chicago
$\frac{00}{01}$ : Aa

#### 5 After you have entered the last character, Press [OK].

#### Tip

Pressing [CLEAR/STOP] deletes characters one by one. When [CLEAR/STOP] is pressed for a few seconds, all the entered characters will be deleted.

## ❑ Relationship between the digital keys and the input character

The character entered by each digital key differs depending on the input mode. The assignment of characters in the character input mode is as follows.

### Characters entered in the character input mode

You can enter the characters displayed on the upper side of the digital keys.

Digital key	Number of times the key is pressed (→)									
1	.	/	@	1						
2	A	B	C	2	a	b	c			
3	D	E	F	3	d	e	f			
4	G	H	I	4	g	h	i			
5	J	K	L	5	j	k	l			
6	M	N	O	6	m	n	o			
7	P	Q	R	S	7	p	q	r	s	
8	T	U	V	8	t	u	v			
9	W	X	Y	Z	9	w	x	y	z	
0	0									
#	<space>- + ~ ! @ # \$ % ^ & * ( ) = _ [ ] { }   < > ; : ' " , . / \ ?									

#### Tip

Depending on the entry situation, some characters cannot be entered.

## ■ Scan speed

The scan speed depends on the selected color mode and resolution settings.

The approximate scan speed (for A4/LT) at each color mode (BLACK / GRAY SCALE: when performing Scan to USB Memory, FULL COLOR: when using the TWAIN driver) and the resolution is listed in the table below.

Color Mode	Resolution	Scan Speed	
BLACK	150 dpi	25 pages/minute	
	200 dpi		
	300 dpi		
	400 dpi		
	600 dpi		
GRAY SCALE	150 dpi	23 pages/minute	
	200 dpi		
	300 dpi		
	400 dpi		
	600 dpi	22 pages/minute	
FULL COLOR	150 dpi	24 pages/minute	
	200 dpi	18 pages/minute	
	300 dpi		
	400 dpi		7 pages/minute <sup>*1</sup>
	600 dpi		7 pages/minute <sup>*2</sup>

\*1 Available only A4/LT or smaller size

\*2 Available only A5-R/ST-R

---

The color mode and resolution settings can be changed on the scan setting screen. For details, see the following sections:

 P.149 “Selecting the color mode”

 P.149 “Selecting the resolution”



# Using Templates (Scan)

Once you have set the several functions and settings, you can register up to three of them as “templates” and recall one of them for frequent use.

## ■ Registering the templates

- 1 Make settings for the functions to register as a template.
- 2 Press [TEMPLATE].

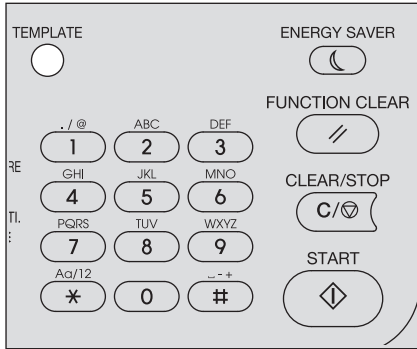

- 3 Press  $\nabla$  or  $\triangle$  to select “REGISTRATION”, and then press  $\triangleright$ .

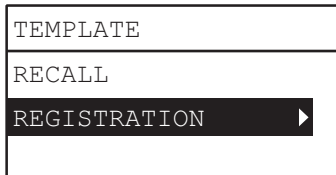

**Note**

To register a template, you must set the destination for the scanned data.

- 4 Press  $\nabla$  or  $\triangle$  to select a template, and then press [OK].

**Note**

- You can register three templates for scanning.
- The settings are overwritten if you select an existing template.
- Update the recipients of the template if you have updated the address book.
- You can also register and edit templates with TopAccess. For details, refer to the *TopAccess Guide*.

You can specify the following items in scan templates.

### Basic setting

No.	Item Name	Settings
1	Scan to (Agent)	E-MAIL, FILE, USB
2	Color Mode	BLACK, GRAY SCALE, FULL COLOR
3	Resolution	150dpi, 200dpi, 300dpi, 400dpi*1, 600dpi*2
4	Single/2-Sided Scan	SINGLE, DUPLEX
5	Original Size	AUTO SIZES, A3, A4, A4-R, A5-R, B4, B5, B5-R, FOLIO, 8K, 16K, 16KR, LD, LG, LT, LT-R, COMP, 13"LG, ST-R, 8.5"SQ
6	Mixed Original Size	OFF, ON
7	Original Mode	TEXT/PHOTO, TEXT, PHOTO, BACKGROUND ERASE
8	Rotation	$\rightarrow$ $\rightarrow$
9	Compress	LOW, MID, HIGH

No.	Item Name	Settings
10	Omit Blank Page	OFF, ON
11	Exposure	AUTO, MANUAL(±4)
12	Continue Scan* <sup>3</sup>	OFF, ON

\*1 When the "FULL COLOR" mode has been selected, you cannot select the original size larger than A4 or LT.

\*2 When the "FULL COLOR" mode has been selected, you can select "600 dpi" only for the original of A5-R or ST-R size.

\*3 This item is available only when the Reversing Automatic Document Feeder (RADF) is installed.

### Scan to E-mail

No.	Item Name	Settings
1	Destination	TO, CC
2	File Format	PDF(SINGLE), PDF(MULTI), TIFF(SINGLE), TIFF(MULTI), JPEG
3	File Name	The default value or the file name entered from the control panel.
4	Message size	NONE, 64, 128, 256, 512, 1024, 2048
5	Subject*	
6	From Address*	Specify with the administrator privilege or enter from the control panel.
7	From Name*	Specify with the administrator privilege or enter from the control panel.
8	Body*	Specify with the administrator privilege or enter from the control panel.

### Scan to File

No.	Item Name	Settings
1	Destination	REMOTE1, REMOTE2
2	File Format	PDF(SINGLE), PDF(MULTI), TIFF(SINGLE), TIFF(MULTI), JPEG
3	File Name	The default value or the file name entered from the control panel.

### Scan to USB

No.	Item Name	Settings
1	File Format	PDF(SINGLE), PDF(MULTI), TIFF(SINGLE), TIFF(MULTI), JPEG
2	File Name	The default value or the file name entered from the control panel.

\* Specify from the control panel by modifying the value that has been set with the administrator privilege or the default value.

## ■ Recalling a template

- 1 Press [TEMPLATE].
- 2 Press ▾ or ▲ to select "RECALL", and then press ▷.

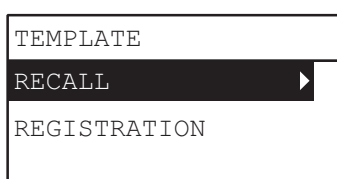

- 3 Press ▾ or ▲ to select a template, and then press [OK].

## VARIOUS FUNCTIONS

<b>Copy Menu List</b> .....	<b>164</b>
Copy menu items .....	164
<b>Scan Menu List</b> .....	<b>165</b>
Scan menu items .....	165
<b>Network Menu List</b> .....	<b>168</b>
NIC status .....	168
Setting the Ethernet speed.....	168
Setting the TCP/IP protocol.....	169
Setting the HTTP network service.....	170
<b>User Functions Menu List</b> .....	<b>171</b>
User functions menu items .....	172
<b>Department Management</b> .....	<b>183</b>
<b>Job Status</b> .....	<b>185</b>
JOB STATUS menu items.....	185

















## Copy Menu List

See the following page for information on using the copy menu.

 P.33 "COPY FUNCTIONS"

### ■ Copy menu items

When you press  $\nabla$  or  $\triangle$  on the main screen (Copy), you enter the copy menu which allows you to use copy functions. The table below shows the functions and reference pages available in the copy menu.

Menu Functions	Settings		Description and Reference Pages
EXPOSURE	AUTO, Manual		Sets the density level for the copied image.  P.40 "Adjusting the exposure"
ORIGINAL MODE	TEXT/PHOTO, TEXT, PHOTO, BACKGROUND ERASE		Sets an original mode suitable for the image being copied.  P.41 "Selecting the original mode"
DRAWER	Drawer 1 XX to Drawer 4 XX, Bypass XX, APS		Sets the paper source.  P.42 "Selecting the paper"
ZOOM	Manual zoom (25 - 100 - 400%), FIXED ZOOM, AMS		Sets the zoom ratio for copied images.  P.44 "Enlarging or reducing the copy size"
FINISHING	NON SORT, SORT, ROTATE SORT		Sets the finishing mode for ejecting copies.  P.49 "Sorting pages"
2IN1/4IN1	OFF, 2IN1, 4IN1		Copies two or four originals onto one sheet of paper.  P.51 "Copying two or four pages on each sheet"
ID CARD	OFF, ON		Sets the ID card function.  P.53 "Copying both sides of a card on a sheet"
EDGE ERASE	OFF, ON (4 to 15 mm (0.2 to 0.6"))		Sets the edge erase function.  P.55 "Erasing the shadow on edges"
DUAL PAGE	OFF, ON		Sets the dual page function.  P.56 "Copying right and left pages separately"
IMAGE SHIFT	OFF, LEFT MARGIN, RIGHT MARGIN		Sets the image shift function.  P.57 "Shifting the pages to the right or left"
2-SIDED	1 > 1 SIMPLEX, 1 > 2 DUPLEX, 2 > 2 DUPLEX, 2 > 1 SPLIT,	BOOK, TABLET	Sets the 2-sided function.  P.58 "Copying on one or both sides"
ANNOTATION	OFF, PAGE NO., PAGE No.+DATE/TIME		Sets the annotation function.  P.61 "Adding a page number and date/time on the copied paper"
OMIT BLANK PAGE	OFF, ON		Sets the omit blank page function.  P.61 "Removing blank pages"
MIXED SIZE ORIGINAL	OFF, ON		Sets the mix-original function.  P.62 "Copying different sizes in one go"
IMAGE DIRECTION	OFF, ON		Sets the image direction function.  P.63 "Image direction"
CONTINUE SCAN	OFF, ON		Sets the scan continuation function.  P.64 "Continuing the scanning for a copy"





## Scan Menu List

See the following page for information on using the scan menu.





 P.117 “SCAN FUNCTIONS”

### ■ Scan menu items

When you press  $\nabla$  or  $\triangle$  on the main screen (Scan), you enter the scan menu which allows you to use basic and advanced scan functions. The table below shows the functions and reference pages available in the scan menu.

Menu Functions		Reference Pages
E-MAIL	E-MAIL ADDRESS	 P.165 “E-mail functions”
	FILE NAME(MAX128)	
	FILE FORMAT	
	MESSAGE SIZE	
FILE	REMOTE1	 P.166 “File functions”
	REMOTE2	
	FILE NAME(MAX128)	
	FILE FORMAT	
USB	FILE NAME(MAX128)	 P.166 “USB functions”
	FILE FORMAT	
MOBILE	FILE NAME(MAX128)	 P.167 “Mobile functions”
	FILE FORMAT	
COLOR MODE		 P.167 “Basic setting functions”
RESOLUTION		
SINGLE/2-SIDED SCAN		
ORIGINAL SIZE		
MIXED SIZE ORIGINAL		
ORIGINAL MODE		
ROTATION		
COMPRESS		
OMIT BLANK PAGE		
EXPOSURE		
CONTINUE SCAN		

### □ E-mail functions

Menu Functions	Settings	Description and Reference Pages	
E-MAIL ADDRESS	TO (ADDRESS) CC (ADDRESS)	REVIEW LIST	You can select from the Address Book or directly enter the address.  P.137 “Procedure for Scan to E-Mail”  P.154 “Specifying E-mail Addresses”
		INPUT ADDRESS	
		SEARCH	
		SINGLE NUMBER	
		GROUP NUMBER	
FILE NAME(MAX128)	You can use up to 128 characters.	Enter the file name to save.  P.137 “Procedure for Scan to E-Mail”  P.158 “Character entry”	

Menu Functions	Settings		Description and Reference Pages
FILE FORMAT	PDF	MULTI	Sets the file format to attach the scanned data to the E-mail. 📖 P.137 "Procedure for Scan to E-Mail"
		SINGLE	
	TIFF	MULTI	
		SINGLE	
JPEG			
MESSAGE SIZE	NONE, 64, 128, 256, 512, 1024, 2048		When the scanned data is bigger than the selected size, divides the data into the set size before sending the E-mail. 📖 P.137 "Procedure for Scan to E-Mail"

## ☐ File functions

Menu Functions	Settings		Description and Reference Pages
REMOTE1/2	Displays only.		Displays the set destination. 📖 P.140 "Procedure for Scan to File"
FILE NAME(MAX128)	You can use up to 128 characters.		Enter the file name to save. 📖 P.140 "Procedure for Scan to File" 📖 P.158 "Character entry"
FILE FORMAT	PDF	MULTI	Sets the file format to save. 📖 P.140 "Procedure for Scan to File"
		SINGLE	
	TIFF	MULTI	
		SINGLE	
JPEG			

## ☐ USB functions

Menu Functions	Settings		Description and Reference Pages
FILE NAME(MAX128)	You can use up to 128 characters.		Enter the file name to save. 📖 P.143 "Procedure for Scan to USB Memory" 📖 P.158 "Character entry"
FILE FORMAT	PDF	MULTI	Sets the file format to save. 📖 P.143 "Procedure for Scan to USB Memory"
		SINGLE	
	TIFF	MULTI	
		SINGLE	
JPEG			

## ☐ Mobile functions

Menu Functions	Settings	Description and Reference Pages
FILE NAME(MAX128)	You can use up to 128 characters.	Enter the file name to save. P.146 "Procedure for Scan to Mobile" P.158 "Character entry"
FILE FORMAT	PDF	Sets the file format to save. P.146 "Procedure for Scan to Mobile"
	MULTI	
	SINGLE	
	TIFF	
	MULTI	
	SINGLE	
	JPEG	

## ☐ Basic setting functions

Menu Functions	Settings	Description and Reference Pages
COLOR MODE	BLACK, GRAY SCALE, FULL COLOR	Sets the color mode for the scanned data. P.149 "Selecting the color mode"
RESOLUTION	600dpi* <sup>1</sup> , 400dpi* <sup>2</sup> , 300dpi, 200dpi, 150dpi	Sets the resolution for the scanned data. P.149 "Selecting the resolution"
SINGLE/2-SIDED SCAN	SINGLE, DUPLEX	Sets the type of originals to scan. P.150 "Scanning the 2-sided originals"
ORIGINAL SIZE	AUTO SIZES, A3, A4, A4-R, A5-R, B4, B5, B5-R, FOLIO, 8K, 16K, 16KR, LD, LG, LT, LT-R, COMP, 13"LG, ST-R, 8.5SQ	Sets the size for the original to scan. P.150 "Selecting the original size"
MIXED SIZE ORIGINAL	OFF, ON	Sets the mix-original function. P.151 "Scanning different sizes in one go"
ORIGINAL MODE	TEXT, TEXT/PHOTO, PHOTO	Sets the type of the original to scan. P.151 "Selecting the original mode"
ROTATION	→  ,  →	Rotates the scanned data to save. P.152 "Selecting the orientation"
COMPRESS	LOW, MID, HIGH	Sets the compression ratio for the scanned image data. P.152 "Selecting the compression ratio"
OMIT BLANK PAGE	OFF, ON	Sets whether to remove blank pages from the scan result. P.153 "Removing blank pages"
EXPOSURE	AUTO, Manual	Sets the density level for the scanned image data. P.153 "Adjusting the exposure"
CONTINUE SCAN	OFF, ON	Sets the scan continuation function. P.154 "Continuing the scanning"

\*1 When the "FULL COLOR" mode has been selected, you can select "600 dpi" only for the original of A5-R or ST-R size.

\*2 When the "FULL COLOR" mode has been selected, you cannot select the original size larger than A4 or LT.

## Network Menu List

You can set various network functions.

### Tip

For instructions on how to display the NETWORK menu, see the following page:

 P.171 “User Functions Menu List”

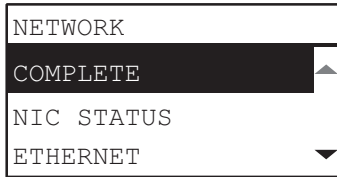

 P.168 “NIC status”

 P.168 “Setting the Ethernet speed”

 P.169 “Setting the TCP/IP protocol”

 P.170 “Setting the HTTP network service”

### Note

Once the network has been set up, exit from USER FUNCTIONS menu by pressing [CANCEL] or [USER FUNCTIONS] button. When “APPLY AND REBOOT?” message appears, select “YES”, and then press [OK]. The equipment is automatically rebooted and the network settings are applied.

## ■ NIC status

You can confirm the current network communication status.

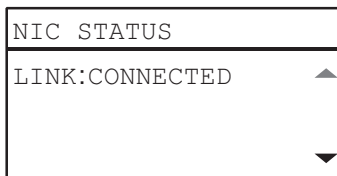

## ■ Setting the Ethernet speed

You can specify the Ethernet speed.

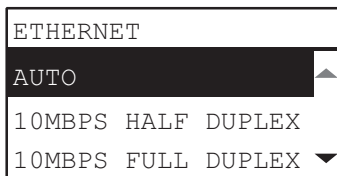

Item name	Description
AUTO 10MBPS HALF DUPLEX 10MBPS FULL DUPLEX 100MBPS HALF DUPLEX 100MBPS FULL DUPLEX	Select the desired combination of communication speed and transmission method.

### Note

If the network is not stable, turn the power of the equipment OFF and then back ON.



## ■ Setting the TCP/IP protocol

You can set the TCP/IP protocol that is commonly used in most network systems. When using Web-based utilities such as TopAccess or network features of this equipment such as network printing and network scanning, you are required to set the TCP/IP protocol.

In the TCP/IP setting operation, you can select the addressing mode, as well as assign the IP address, subnet mask and default gateway (when manually assigned).

How the TCP/IP protocol must be set depends on your network environment.

TCP/IP
ADDRESS MODE ▶
IP ADDRESS
SUBNET MASK ▼

Item name	Description
ADDRESS MODE	<ul style="list-style-type: none"> <li>• <b>STATIC IP</b> (When connecting to a local area network using static IP addresses) Select [STATIC IP] and specify an IP address when connecting to a local area network where static IP addresses are used. Also set the subnet mask and default gateway as required.</li> <li>• <b>DYNAMIC</b> (When TCP/IP is set by Auto-IP addressing or DHCP server) Select [DYNAMIC] when you do not know the TCP/IP settings that should be assigned to the equipment. If [DYNAMIC] is selected when your network supports the DHCP, the IP address, subnet mask, default gateway, primary WINS server address, secondary WINS server address, POP3 server address, and SMTP server address are acquired from the DHCP server. If the DHCP is not supported, an appropriate IP address is assigned to this equipment by the auto-IP addressing function. However, the auto-IP addressing may not work properly if a router is placed in the network.</li> <li>• <b>NO AUTO IP</b> (When TCP/IP is set using only the DHCP server) Select [NO AUTO IP] when the equipment is connected to a local area network with a DHCP server and you want to set the TCP/IP not using the auto-IP addressing function, but only the DHCP. When [NO AUTO IP] is selected, the IP address, subnet mask, default gateway, primary WINS server address, secondary WINS server address, POP3 server address, and SMTP server address are acquired from the DHCP server, and the IP address assignment by the auto-IP addressing function is disabled.</li> </ul>
IP ADDRESS SUBNET MASK DEFAULT GATEWAY	<p>Press [IP ADDRESS] and enter the IP address of this equipment using the digital keys. Enter the subnet mask and default gateway as required. Use △ or ▼ to switch the active box.</p> <p><b>Note</b> This item is enabled only when [STATIC IP] is selected for [ADDRESS MODE].</p>

### Tip

Use the digital keys to enter [IP ADDRESS] or [SUBNET MASK] or [DEFAULT GATEWAY].  
For entering characters, see the following page.

📖 P.158 “Character entry”

---

## ■ Setting the HTTP network service

You can enable or disable the HTTP network server service that provides web-based utilities on this equipment, such as TopAccess.

HTTP
HTTP SERVER ▶
PRIMARY PORT NUMBER

Item name	Description
HTTP SERVER	<ul style="list-style-type: none"><li>• ENABLE — Press this button to use the HTTP network server service.</li><li>• DISABLE — Press this button to disable the HTTP network server service.</li></ul> This option must be enabled for TopAccess.
PRIMARY PORT NUMBER	Press this button to enter the primary port number to be used for receiving HTTP access from other clients. Normally use the default port number “80”.

### Tip

Use the digital keys to enter [PRIMARY PORT NUMBER].

For entering characters, see the following page.

 P.158 “Character entry”

# User Functions Menu List

Before you start operating the “USER FUNCTIONS” menu, learn the general procedure below.

## Tip

- Press [CANCEL] to exit from the setting without making any changes. You can also exit with the ◀ button if it is active.
- Press [CLEAR/STOP] to delete a character. Keep pressing [CLEAR/STOP] for a second to clear all characters.

## 1 Press [USER FUNCTIONS].

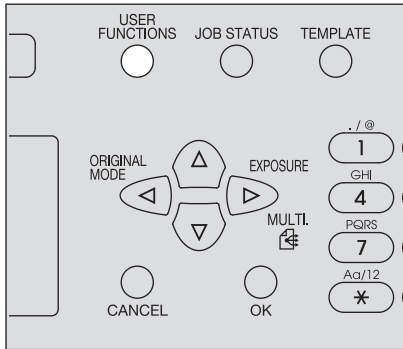

## 2 Press ▾ or ▲ to scroll the menu, and then press ▶ to enter the function menu.

📖 P.172 “User functions menu items”

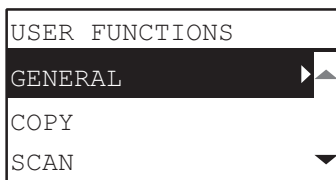

## 3 Press ▾ or ▲ to scroll the menu, and then press ▶ to select the function.

## 4 Press ▾ or ▲ to scroll the menu, and then press ▶ to select the settings for each function.

## 5 Press ▾, ▲, ▶, or ◀ to select a setting, and then press [OK].

- Continues to the next step if the selected setting has more options or values.
- Exits from the menu if the selected setting has no more options or values. At this point, the operation is complete.

## 6 Make option settings with ▾, ▲, ▶, or ◀, or enter characters using the digital keys, and then press [OK].

- Repeat this step if the selected setting has more options or values.
- Exits from the menu if the selected setting has no more options or values. At this point, the operation is complete.

## Tip

The options or values vary depending on the function.

- 📖 P.174 “GENERAL”
- 📖 P.177 “COPY”
- 📖 P.178 “SCAN”
- 📖 P.179 “USB PRINT”
- 📖 P.180 “LIST”
- 📖 P.180 “WIRELESS SETTING”
- 📖 P.182 “ADDRESS BOOK”
- 📖 P.182 “DRAWER”
- 📖 P.182 “INFORMATION”

## ■ User functions menu items

When you press [USER FUNCTIONS] on the main screen (Copy), you enter the “USER FUNCTIONS” menu which enables you to change each setting and execute the device functions.

The table below shows the functions and reference pages available in the “USER FUNCTIONS” menu.

Menu Functions		Reference Pages	
GENERAL	CHANGE LANGUAGE	P.174 “GENERAL”	
	CLOCK		
			DATE/TIME
			DATE FORMAT
	WALKUP SCREEN		
	TIMERS		AUTO POWER SAVE
			SLEEP MODE
			AUTO CLEAR
			WEEKLY TIMER
	DEPARTMENT CODE		
	POP UP		DRAWER SET
			PAPER JAM RECOVERY
	LCD CONTRAST		
	USB WAKEUP		
	NETWORK		COMPLETE
			NIC STATUS
			ETHERNET
			TCP/IP
			HTTP
	SERVICE NOTIFY <sup>*1</sup>		E-MAIL SETTINGS
			CUSTOMER INFO.
	SUPPLY NOTICE		DESTINATION SETUP
			AUTO DETECT
			OTHER INFORMATION
	AUTO CALIBRATION		TEXT CALIBRATION
			PHOTO CALIBRATION
			DEFAULT SETTING

Menu Functions		Reference Pages	
COPY	EXPOSURE	📖 P.177 "COPY"	
	EXPOSURE LEVEL		AUTO LEVEL
			MANUAL LEVEL
	ORIGINAL MODE		
	MAXIMUM COPIES		
	SORT MODE PRIORITY		
	AUTO 2-SIDED MODE		
	2IN1/4IN1		ORIGINAL SIZE
			ORIG. ORIENTATION
			PAGE LAYOUT
	BACKGROUND		
	SHARPNESS		
	OMIT BLANK PAGE		
CONTINUE SCAN			
A4-R/LG SWITCH			
SCAN	COLOR MODE	📖 P.178 "SCAN"	
	COMPRESS		
	2-SIDED SCAN		
	ROTATION		
	BLACK SETTING		RESOLUTION
			ORIGINAL MODE
			EXPOSURE
	GRAY SETTING		RESOLUTION
	FULL COLOR SETTING		RESOLUTION
			ORIGINAL MODE
	OMIT BLANK PAGE		
CONTINUE SCAN			
A4-R/LG SWITCH			
FAX	TERMINAL ID	For details of the fax settings, see the <b>Fax Guide</b> .	
	INITIAL SETUP		
	RX PRINT		
USB PRINT	PAPER SIZE	📖 P.179 "USB PRINT"	
	A3, A4, B4, B5, A5-R, FOLIO, LD, LG, LT, COMP, 13"LG, ST-R, 8.5SQ		
	2-SIDED	SINGLE, DUPLEX	
REPORT SETTING	AUTO JOURNAL	For details of the fax settings, see the <b>Fax Guide</b> .	
	MEMORY TX		
	MULTI TX		

Menu Functions			Reference Pages
LIST	ADDRESS BOOK		📖 P.180 "LIST"
	FUNCTION		
	COUNTER		
	DEPARTMENT		
	PCL FONT		
	PS FONT* <sup>2</sup>		
WIRELESS SETTING	-		📖 P.180 "WIRELESS SETTING"
ADDRESS BOOK	E-MAIL	SINGLE NUMBER	📖 P.182 "ADDRESS BOOK"
		GROUP NUMBER	
	PHONE BOOK	SPEED DIAL	
		GROUP DIAL	
		ONE TOUCH	
DRAWER	DRAWER 1		📖 P.182 "DRAWER"
	DRAWER 2		
	DRAWER 3		
	DRAWER 4		
INFORMATION	COUNTER	TOTAL COUNTER	📖 P.182 "INFORMATION"
	TONER REMAIN		
	SERIAL NUMBER		

\*1 This item is not displayed depending on the destinations.

\*2 This item is displayed when the PostScript kit has been installed.

## ☐ GENERAL

Menu Functions		Settings	Description
CHANGE LANGUAGE		S-CHINESE (SIMPLIFIED CHINESE), T-CHINESE (TRADITIONAL CHINESE), JAPANESE, ENGLISH, FRENCH, ITALIAN, GERMAN, POLISH, RUSSIAN, SPANISH, SWEDISH, NORWEGIAN, FINNISH, DANISH, DUTCH, PORTUGUESE, CZECH, HUNGARIAN, ROMANIAN, SLOVAKIAN, LITHUANIAN, IRISH, SLOVENIAN, BULGARIAN, LATVIAN, SERBIAN, TURKISH	Sets the default language. The default language and the appearance order vary depending on the region.
CLOCK	DATE/TIME	YYYY/MM/DD HH:MM Year:2012 - 2037 Month:01 - 12 Day:01 - 28, 29, 30, 31 Hour:00 - 23 Minute:00 - 59	Sets the date and time.
	DATE FORMAT	MM/DD/YY DD/MM/YY YY/MM/DD	Sets the data format.

Menu Functions		Settings	Description	
WALKUP SCREEN		COPY, SCAN, FAX	Sets the start screen.	
TIMERS	AUTO POWER SAVE	1, 3, 4, 5, 7, 10, 15, 20, 30, 45, 60	Sets the period of time (in minutes) that this equipment should wait before low power mode is activated.	
	SLEEP MODE	1, 3, 5, 10, 15, 20, 25, 30, 40, 50, 60	Sets the period of time (in minutes) that this equipment should wait before sleep mode is activated.	
	AUTO CLEAR	15, 30, 45, 60, 75, 90, 105, 120, 135, 150	Sets the time (in seconds) to clear the previous settings and return to the main screen.	
	WEEKLY TIMER	OFF, ON (SUNDAY, MONDAY, TUESDAY, WEDNESDAY, THURSDAY, FRIDAY, SATURDAY)	Sets the time to enter energy saving mode and the time to exit the energy saving mode for each day from Sunday to Saturday.	
DEPARTM ENT CODE	YES	MASTER CODE/ DEPARTMENT CODE	NUMBER (01 to 99)	Sets the department number in the range from "2" to "99". ("01" is already registered as the master code (administrator's code).)
			NAME (max 20 characters)	Enter the department name. 📖 P.158 "Character entry"
			CODE (5 digits)	Sets the 5-digit number for master code or department code. Entered numbers are displayed as asterisks (*). Existing codes cannot be entered.  <b>Note</b> Do not forget this 5-digit number for master code because it is required for setting or deleting each department code.
	NO	-	Department code is not set.	
POP UP	DRAWER SET	ENABLE, DISABLE	Sets whether to display a pop-up message on the LCD screen in the following cases. <ul style="list-style-type: none"> <li>• When the size of paper loaded in the drawer differs from setting.</li> <li>• When a paper misfeed occurs.</li> </ul>	
	PAPER JAM RECOVERY	ENABLE, DISABLE		
LCD CONTRAST		-3 (Light) to +3 (Dark)	Sets the brightness of LCD screen.	
USB WAKEUP		OFF, ON	Sets whether the equipment wakes up from the sleep mode by detecting the USB cable.	

Menu Functions		Settings	Description	
NETWORK	COMPLETE	-	Completes the network settings.	
	NIC STATUS	-	Displays the current network communication status.	
	ETHERNET	AUTO, 10MBPS HALF DUPLEX, 10MBPS FULL DUPLEX, 100MBPS HALF DUPLEX, 100MBPS FULL DUPLEX	Select the desired combination of communication speed and transmission method.	
	TCP/IP	ADDRESS MODE	STATIC IP, DYNAMIC, NO AUTO IP	Sets a method for specifying an IP address.
		IP ADDRESS	000.000.000.000 - 255.255.255.255	Sets the IP address of this equipment.
		SUBNET MASK	000.000.000.000 - 255.255.255.255	Sets the subnet mask of this equipment.
		DEFAULT GATEWAY	000.000.000.000 - 255.255.255.255	Sets the default gateway of this equipment.
	HTTP	HTTP SERVER	ENABLE, DISABLE	Sets whether to use the HTTP network server service.
		PRIMARY PORT NUMBER	1 - 65535	Sets the primary port number to be used for receiving HTTP access from other clients. Normally use the default port number "80".
SERVICE NOTIFY <sup>1</sup>	E-MAIL SETTINGS	SEND NOW	YES, NO	Sets the e-mail settings for service notification.
		E-MAIL ADDRESS1	-	
		E-MAIL ADDRESS2	-	
		E-MAIL ADDRESS3	-	
	CUSTOMER INFO.	CUSTOMER NAME	-	Sets the customer information for service notification.
		CUSTOMER TEL NO.	-	
		CUSTOMER E-MAIL	-	









Menu Functions		Settings	Description	
SUPPLY NOTICE*1	DESTINATION SETUP	FAX NUMBER	-	Sets the contact information for ordering supplies.
		E-MAIL	-	
	AUTO DETECT		OFF, ON	Sets whether to detect information automatically.
	OTHER INFORMATION	CUSTOMER NUMBER	-	Sets other various contact information.
		CONTACT NAME	-	
		CONTACT TEL NUMBER	-	
SHIP TO NAME		-		
SHIP TO ADDRESS	-			
AUTO CALIBRATION		TEXT CALIBRATION, PHOTO CALIBRATION, DEFAULT SETTING	You can automatically calibrate the color gradation when the shading and hue are not reproduced accurately in the images scanned by this equipment.	



\*1 This item is not displayed depending on the destinations.

## ☐ COPY

Menu Functions		Settings	Description
EXPOSURE		AUTO, Manual	Sets the default setting for the density. You can change the exposure from lighter to darker in nine steps from -4 to +4.
EXPOSURE LEVEL	AUTO LEVEL	-2 to +2	Sets the center value for adjusting the density with EXPOSURE.
	MANUAL LEVEL	-2 to +2	Sets the center value for adjusting the density with EXPOSURE.
ORIGINAL MODE		TEXT/PHOTO, TEXT, PHOTO, BACKGROUND ERASE	Sets the default setting for the original mode.
MAXIMUM COPIES		9, 99, 999	Sets the maximum number of copies to be allowed.
SORT MODE PRIORITY		NON SORT, SORT, ROTATE SORT	Sets the default sort mode for copy jobs.
AUTO 2-SIDED MODE		OFF, 1 > 2 DUPLEX, 2 > 2 DUPLEX, USER	Sets the default auto 2-sided mode for copy jobs.

Menu Functions		Settings	Description
2IN1/4IN1	ORIGINAL SIZE	A3, A4, A5, B4, B5, FOLIO, 8K, 16K, LD, LG, LT, COMP, 13"LG, ST, 8.5SQ	Sets the default setting for the original size when using the "2IN1/4IN1" function.
	ORIG. ORIENTATION	Portrait, Landscape	Sets the default setting for the original orientation when using the "2IN1/4IN1" function.
	PAGE LAYOUT	2IN1:   4IN1:    	Sets the order of the pages when using the "2IN1/4IN1" function.
BACKGROUND		-4 to +4	Adjusts the density of the original's background. It avoids the back side of a 2-sided original becoming visible on its front side. You can change the background from lighter to darker in nine steps from -4 to +4.
SHARPNESS		-4 to +4	Emphasizes or blurs the outline of the image. You can change the sharpness from softer to sharper in nine steps from -4 to +4.
OMIT BLANK PAGE		-3 to +3	Sets the sensitivity level to detect blank pages. The higher the level is, the more likely the equipment can detect blank pages. You can specify the sensitivity level in the range from -3 to +3.
CONTINUE SCAN		OFF, ON	Sets whether to continue scanning when the scanning of all the originals set on the RADF is finished.
A4-R/LG SWITCH		A4-R, LG	Switches the size between A4-R or LG when scanning an LG size original set on the Reversing Automatic Document Feeder (RADF).

## ☐ SCAN

Menu Functions		Settings	Description
COLOR MODE		BLACK, GRAY SCALE, FULL COLOR	Sets the default setting for the color mode.
COMPRESS		LOW, MID, HIGH	Sets the default setting for the compression ratio.
2-SIDED SCAN		SINGLE, DUPLEX	Sets the default setting for the 2-sided scan mode.
ROTATION		 	Sets the default setting for the orientation.

Menu Functions		Settings	Description
BLACK SETTING	RESOLUTION	600dpi, 400dpi, 300dpi, 200dpi, 150dpi	Sets the default setting for the resolution when [BLACK] is selected for the color mode setting.
	ORIGINAL MODE	TEXT/PHOTO, TEXT, PHOTO	Sets the default setting for the original mode when [BLACK] is selected for the color mode setting.
	EXPOSURE	AUTO, Manual	Sets the default setting for the density when [BLACK] is selected for the color mode setting.
GRAY SETTING	RESOLUTION	600dpi, 400dpi, 300dpi, 200dpi, 150dpi	Sets the default setting for the resolution when [GRAY SCALE] is selected for the color mode setting.
FULL COLOR SETTING	RESOLUTION	300dpi, 200dpi, 150dpi	Sets the default setting for the resolution when [FULL COLOR] is selected for the color mode setting.
	ORIGINAL MODE	TEXT/PHOTO, TEXT, PHOTO	Sets the default setting for the original mode when [FULL COLOR] is selected for the color mode setting.
OMIT BLANK PAGE		-3 to +3	Sets the sensitivity level to detect blank pages. The higher the level is, the more likely the equipment can detect blank pages. You can specify the sensitivity level in the range from -3 to +3.
CONTINUE SCAN		OFF, ON	Sets whether to continue scanning when the scanning of all the originals set on the RADF is finished.
A4-R/LG SWITCH		A4-R, LG	Switches the size between A4-R or LG when scanning an LG size original set on the Reversing Automatic Document Feeder (RADF).

## ☐ USB PRINT

The following functions and settings are available on the “USB PRINT” menu.

Menu Functions	Settings	Description
PAPER SIZE	A3, A4, B4, B5, A5-R, FOLIO, LD, LG, LT, COMP, 13"LG, ST-R, 8.5SQ	Sets the paper size to print files from a USB storage device.
2-SIDED	SINGLE	Prints on a single side of paper.
	DUPLEX	Prints on both sides of paper.

## □ LIST

Menu Functions	Settings	Description
ADDRESS BOOK	SPEED DIAL, GROUP DIAL, ONE TOUCH	Prints the E-mail address list. For details of the fax settings, see the <b>Fax Guide</b> .
FUNCTION	-	Prints the user function list.
COUNTER	-	Prints the total counter list.
DEPARTMENT	-	Prints the department code and the counter value. The printed counter value is for the department you specified in the department code entry screen. Enter the master code in the department code entry screen if you want to print counter values of all the registered departments.
PCL FONT	-	Prints the list of PCL fonts.
PS FONT*	-	Prints the list of PS fonts.

\* This item is displayed when the PostScript kit has been installed.

## □ WIRELESS SETTING

You can configure the Wireless LAN Module if it is installed.  
Select Infrastructure Mode or AP Mode to specify the security mode.

### Note

- If you set no security, anyone knows how the SSID can connect to the wireless network. Therefore, it is recommended to set the security if it is possible.
- When the mode has been switched between Infrastructure Mode and AP Mode, or when the WIRELESS SETTING has been completed and the USER FUNCTIONS menu has been finished by pressing the [CANCEL] or [USER FUNCTIONS] button, “APPLY AND REBOOT?” appears. Select “YES” and then press [OK]. The equipment is automatically rebooted and the WIRELESS SETTING is applied.
- WPS  
WPS is a standard to allow easy wireless LAN configurations. This equipment supports Push Button Configuration and PIN methods.
- WPA2-PSK, WPA2/WPA-PSK  
WPA2 and WPA2/WPA-PSK are authentication methods using the PSK (Pre-Shared Key) between other wireless devices and the Access Point or the equipment to connect.  
To access the wireless network using the WPA2-PSK or WPA2/WPA-PSK authentication, the same PSK passphrase must be assigned in both other wireless devices and the Access Point or the equipment to connect. Use WPA2-PSK for AP Mode.
- WEP  
WEP is a data encryption method using the WEP key between the Access Point and other wireless devices. WEP is less secure compared with WPA2 and WPA2/WPA-PSK. If the wireless network is configured in the Infrastructure Mode and the Access Point supports WPA2-PSK or WPA2/WPA-PSK, it is recommended to use WPA2-PSK or WPA2/WPA-PSK rather than WEP.
- CHANNEL  
When using AP Mode, set it to an unused channel in accordance with the use environment.

The following functions are available on the “WIRELESS SETTING” menu.

Menu Functions			Settings	Description	
ON	INFRASTRUCTURE	WPS	PBC PIN	Selects the connection method from [PBC] or [PIN]. Press the WPS button on the Access Point within 2 minutes of selecting the PBC method. Register the PIN generated by this equipment to the Access Point within 2 minutes of selecting the PIN method.	
		SSID/ SECURITY*	SEARCH	-	Search the Access Point, and specify the password after selecting the SSID.
			MANUAL	-	WPA2-PSK, WPA2/WPA-PSK: Specify the passphrase after selecting AES if you are using WPA2-PSK, or after selecting TKIP+AES if you are using WPA2/WPA-PSK. WEP: Selects the WEP encryption and key entry method, and then enter the WEP key. NONE: Sets no security for wireless access.
	AP MODE	CONNECTION INFO.		-	Confirm the SSID and passphrase for AP Mode, and specify the connection information on the device to connect.
		WPS		PBC PIN	Selects the connection method from [PBC] or [PIN]. Press the WPS button on the device to connect within 2 minutes of selecting the PBC method. Register the PIN code generated by the device to connect or the equipment within 2 minutes of selecting the PIN method.
		SSID/SECURITY*		-	Sets the SSID and passphrase for AP Mode.
		CHANNEL		1 - 11	Sets the channel for AP Mode.
		IP ADDRESS		000.000.000. 000 - 255.255.255. 255	Select [IP ADDRESS] and enter the IP address of this equipment for AP Mode using the digital keys.
		SUBNET MASK		000.000.000. 000 - 255.255.255. 255	Enter the subnet mask for AP Mode.
	OFF			-	Disables the wireless network.

\* Use the digital keys to enter the characters.  
The alphanumeric characters and the following symbols can be used for SSID, passphrase and WEP key (ASCII).  
(space) - + ~ ! @ # \$ % ^ & \* ( ) = \_ [ ] { } | < > ; ' ' " , . / \ ?

#### Note

When the Ethernet function and AP Mode are used simultaneously, IP ADDRESS and SUBNET MASK must be set to the different network segment.

## ❑ ADDRESS BOOK

Menu Functions		Settings	Description
E-MAIL	SINGLE NUMBER	-	Edits the address book for “Scan to E-Mail” function.
	GROUP NUMBER	-	
PHONE BOOK	SPEED DIAL	-	For details of the fax settings, see the <i>Fax Guide</i> .
	GROUP DIAL		
	ONE TOUCH		

## ❑ DRAWER

Menu Functions		Settings	Description
DRAWER 1		A3, A4, A4-R, A5-R, 8K, 16K, 16K-R, B4, B5, B5-R, FOLIO, LD, LG, LT, LT-R, ST-R, COMP, 13" LG, 8.5SQ	Sets the paper size for the drawer.
DRAWER 2			
DRAWER 3			
DRAWER 4			

## ❑ INFORMATION

Menu Functions		Settings	Description
COUNTER	TOTAL COUNTER	-	Displays the total counter.
TONER REMAIN		-	Displays the toner remaining information.
SERIAL NUMBER		-	Displays the serial number.

# Department Management

You can identify the number of output pages by copying, transmitting and receiving faxes, printing, and scanning by user groups (departments) using the department management function.

When the department management function is enabled the department code entry screen is displayed before using this equipment. This can also prevent improper use of this equipment.

 P.18 “Preparation 1 - Turning Power ON”

You can register the department name and code from the [USER FUNCTIONS] menu.

## 1 Press [USER FUNCTIONS].

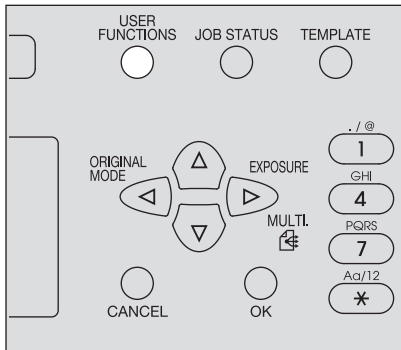

## 2 Press $\nabla$ or $\triangle$ to select [GENERAL] and then press $\triangleright$ .

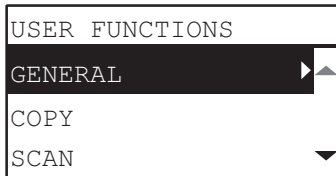

## 3 Press $\nabla$ or $\triangle$ to select [DEPARTMENT CODE] and then press $\triangleright$ .

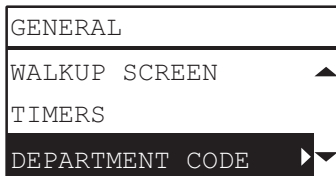

## 4 Press $\nabla$ or $\triangle$ to select [YES] and then press $\triangleright$ .



## 5 Specify the department number, name, and code.

 P.171 “User Functions Menu List”

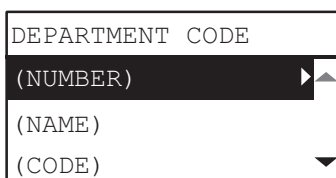

---

**Note**

You need to set the master code (department number: 01) before entering the department code. The master code registration screen is displayed if you have not set the master code.

MASTER CODE	01
(NAME)	▶
(CODE)	
ADD DEPARTMENT	



## Job Status

You can confirm the status of jobs, delete jobs, and print files stored in a USB storage device.

### 1 Press the [JOB STATUS] button.

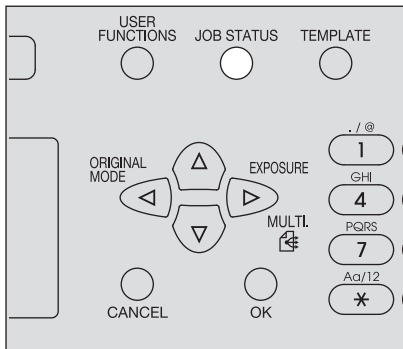

### 2 Press $\nabla$ or $\triangle$ to scroll the menu and then press $\triangleright$ to enter the function menu.

P.185 “JOB STATUS menu items”

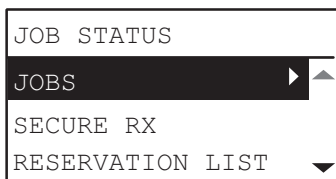

### 3 Press $\nabla$ or $\triangle$ to select the function menu and then start the operation.

## ■ JOB STATUS menu items

When you press the [JOB STATUS] button on the main screen, the JOB STATUS menu appears. On this menu, you can confirm the status of each job, delete jobs, print files from a USB storage device, and print various lists. The table below shows the functions available on the JOB STATUS menu and the reference pages.

Menu Functions		Settings
JOBS	PRINT	CONFIRM
		DELETE
	SCAN	CONFIRM
		DELETE
	FAX <sup>*1</sup>	CONFIRM
		DELETE
USB PRINT		Prints files saved in a USB storage device. P.186 “Printing from a USB storage device”
MOBILE PRINT		Prints files saved in a mobile device. P.187 “Printing from a mobile device”
SECURE RX <sup>*1</sup>		Prints SECURE RECEIVE fax jobs. For details, see the <b>Fax Guide</b> .
RESERVATION LIST <sup>*1</sup>		Prints a list of jobs that are reserved to be sent. For details, see the <b>Fax Guide</b> .
JOURNAL <sup>*1</sup>		Prints a history of fax transmissions and receptions. For details, see the <b>Fax Guide</b> .

<sup>\*1</sup> These menu items are available only for the equipment with the fax unit installed as an option.

## ❑ Confirming the job status and deleting jobs

You can confirm the statuses of print, scan, and fax jobs and delete jobs.

### Confirming the job status

- 1 Press  $\nabla$  or  $\triangle$  to select [JOBS] and then press  $\triangleright$ .
- 2 Press  $\nabla$  or  $\triangle$  to select [PRINT], [SCAN] or [FAX] and then press  $\triangleright$ .
- 3 Press  $\nabla$  or  $\triangle$  to select [CONFIRM] and then press  $\triangleright$ .  
Jobs in progress or those on the waiting list appear.
- 4 Press  $\nabla$  or  $\triangle$  to select the job whose status you want to confirm and then press  $\triangleright$ .  
The status of the selected job appears.
- 5 After you have confirmed the status, press  $\triangleleft$ , [CANCEL] or [OK].  
The menu returns to the previous one.

### Deleting unnecessary jobs

- 1 Press  $\nabla$  or  $\triangle$  to select [JOBS] and then press  $\triangleright$ .
- 2 Press  $\nabla$  or  $\triangle$  to select [PRINT], [SCAN] or [FAX] and then press  $\triangleright$ .
- 3 Press  $\nabla$  or  $\triangle$  to select [DELETE] and then press  $\triangleright$ .  
Jobs in progress or those on the waiting list appear.
- 4 Press  $\nabla$  or  $\triangle$  to select the job you want to delete and then press  $\triangleright$ .  
A message asking you to confirm the deletion appears.

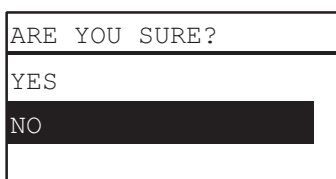

- 5 If you want to continue to delete the job, press  $\triangle$  and select [YES]. Then press [OK].  
The job is deleted.

## ❑ Printing from a USB storage device

You can print PDF, JPEG or TIFF files saved in a USB storage device connected to this equipment.

### Note

- USB storage devices must meet the requirements below. However, some USB storage devices may not be used with this equipment even though the requirements below are met.
  - FAT16 or FAT32 format
  - Single-partition (USB storage devices with multiple partitions are not supported.)
- Only files saved in the root folder of a USB storage device can be printed.
- Up to 99 files can be displayed in alphabetical order.
- When the number of the letters in the file name exceeds 20, the 18th and the subsequent ones are displayed in dots.
- A JPEG file with a resolution higher than 600 dpi cannot be printed.
- Printing of a progressive JPEG file is not possible.
- The compression format of TIFF files is compatible with JPEG/MH/MR/MMR.
- If photo images in a TIFF file have been printed in a grainy fashion, try carrying out the printing from a client computer, and thereby this phenomenon may be improved.
- Only PDF files that have been scanned with the same equipment in the BLACK mode can be printed. (Except for the equipment with GA-1350L/H installed)
- The encrypted PDF files cannot be printed.
- A paper size cannot be set for PDF files. They are printed in the size in which they are scanned.
- When a PDF file is printed by the equipment with GA-1350L/H installed, the setting of duplex printing is disabled. Printing is performed on the one side of paper regardless of the setting.

- TIFF and JPEG files cannot be printed as being scaled according to the paper.

## 1 Connect a USB storage device to the slot of this equipment.

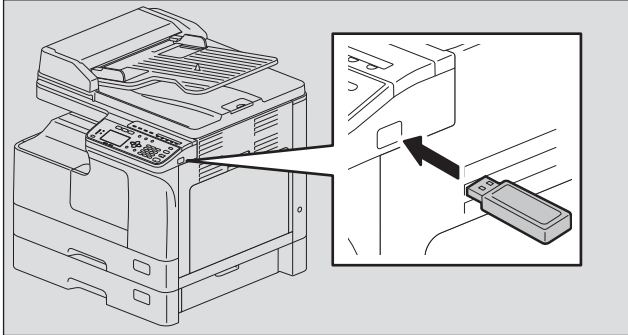

## 2 Select the paper size and set the duplex printing mode in [USB PRINT] of the USER FUNCTIONS menu.

☞ P.179 “USB PRINT”

### Note

The paper size setting is disabled for PDF files as they are printed in the size in which they are scanned.

## 3 Press the [JOB STATUS] button.

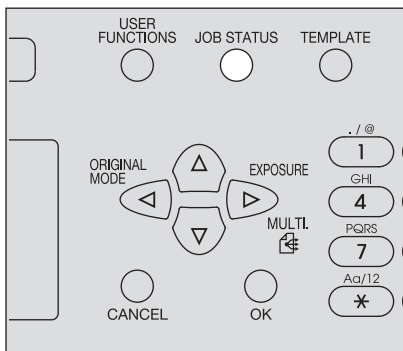

## 4 Press $\nabla$ or $\triangle$ to select [JOBS] and then press $\triangleright$ .

## 5 Press $\nabla$ or $\triangle$ to select [USB PRINT] and then press $\triangleright$ .

## 6 Press $\nabla$ or $\triangle$ to select the file you want to print and then press [OK].

Printing starts.

### Note

Do not remove the USB storage device until printing finishes.

## ☐ Printing from a mobile device

You can print PDF, JPEG or TIFF files saved in an Android device connected to this equipment by a USB cable.

### Note

- Set the USB connection mode of the Android device to connect as a media device (MTP).
- Up to 99 files and folders can be displayed in alphabetical order.
- Up to 19 characters of a file name and folder name are displayed when they exceed 20 characters.
- A JPEG file with a resolution higher than 600 dpi cannot be printed.
- The compression format of TIFF files is compatible with JPEG/MH/MR/MMR.
- If photo images in a TIFF file have been printed in a grainy fashion, try carrying out the printing from a client computer, and thereby this phenomenon may be improved.
- Only PDF files that have been scanned with the same equipment in the BLACK mode can be printed. (Except for the equipment with GA-1350L/H installed)
- The encrypted PDF files cannot be printed.
- A paper size cannot be set for PDF files. They are printed in the size in which they are scanned.

- When a PDF file is printed by the equipment with GA-1350L/H installed, the setting of duplex printing is disabled. Printing is performed on the one side of paper regardless of the setting.
- TIFF and JPEG files cannot be printed as being scaled according to the paper.

**1 Connect an Android device to this equipment by a USB cable.**

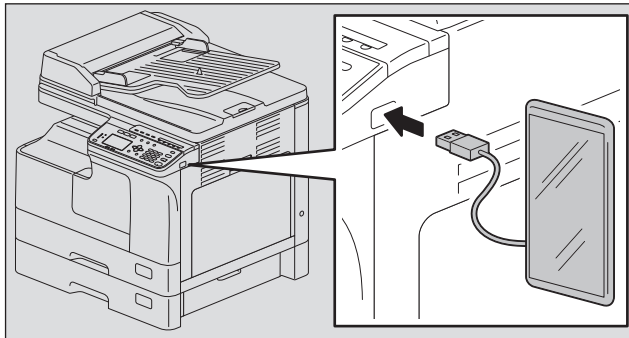

**2 Select the paper size and set the duplex printing mode in [USB PRINT] of the USER FUNCTIONS menu.**

P.179 "USB PRINT"

**Note**

The paper size setting is disabled for PDF files as they are printed in the size in which they are scanned.

**3 Press the [JOB STATUS] button.**

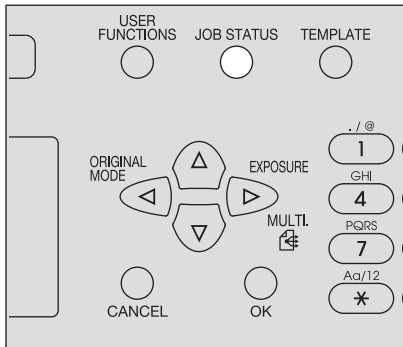

**4 Press  $\nabla$  or  $\triangle$  to select [JOBS] and then press  $\triangleright$ .**

**5 Press  $\nabla$  or  $\triangle$  to select [MOBILE PRINT] and then press  $\triangleright$ .**

**6 Press  $\nabla$  or  $\triangle$  to select the file you want to print and then press [OK].**  
Printing starts.

**Note**

Do not remove the USB cable and the Android device until printing finishes.

# TROUBLESHOOTING

<b>When This Message Appears .....</b>	<b>190</b>
<b>Paper Misfeed .....</b>	<b>193</b>
Find the position of paper misfeeds .....	193
When paper misfeeds occur frequently .....	193
When removing misfed paper .....	193
Paper misfeeds on the Reversing Automatic Document Feeder (RADF).....	194
Paper misfeeds on the bypass tray .....	196
Paper misfeeds inside of the side cover .....	196
Paper misfeeds within the Paper Feed Unit .....	198
Paper misfeeds within the Paper Feed Pedestal.....	199
<b>Replacing Toner Cartridge .....</b>	<b>201</b>
When a message for replacement appears .....	201
<b>Before Calling Service Technician .....</b>	<b>204</b>
General operation .....	204
Toner-related items .....	204
Original/Paper-related items .....	205
Image trouble.....	205

## When This Message Appears

A message appears when a problem occurs on the equipment. Find the message on the list below and follow the instructions in the Countermeasure.

Message	Meaning	Countermeasure
MISFEED xxxx	An error code “xxxx” and a message for solving the problem are displayed.	Remove any misfed paper. 📖 P.193 “Paper Misfeed”
CHECK:PAPER SIZE	The incorrect paper size has been set for paper loaded on the bypass tray.	Remove paper from the bypass tray and load it again so that the display shows “BYPASS PAPER SIZE”. Set the correct paper size. When you load non-standard sized paper, select “CUSTOM” for the paper size.
CLOSE ***	The cover indicated by “***” is not securely closed.	Close the cover securely.
DRAWER * EMPTY	The paper in a drawer indicated by “*” has run out.	Load paper in the drawer. 📖 P.23 “Loading paper in the drawer/Paper Feed Unit”
COUNT OVER	The number of pages scanned has exceeded the maximum value.	Select “PRINT” on the LCD screen to copy the data scanned so far. Select “CANCEL JOB” to delete all the data scanned so far.
CALL FOR SERVICE xxxx	The repair or adjustment by your service technician is needed.	Contact your service representative. Give the service technician the error code (consisting of letters and numbers) that appears in the upper right area of the LCD screen.  ⚠️ <b>WARNING</b> _____  <b>Never attempt to repair, disassemble or modify the equipment by yourself.</b> This could cause an electric shock, a fire or serious injury. Contact your service representative when the equipment is in an abnormal condition or any malfunction is found.
MAINTENANCE	The maintenance by your service technician is needed.	Contact your service representative.
BYPASS EMPTY	Paper set on the bypass tray has run out.	Load paper on the bypass tray. 📖 P.27 “Loading paper on the bypass tray”
TONER IS LOW	There is only a little toner remaining in the toner cartridge.	There is still a little toner remaining in the toner cartridge. Do not replace the toner cartridge until “TONER EMPTY” appears on the LCD screen.  <b>Note</b> <ul style="list-style-type: none"> <li>• The message may not appear because the toner remaining in the cartridge does not lie evenly.</li> <li>• When the message appears, it is advisable to purchase a new recommended cartridge to prepare for its replacement.</li> </ul>
ERROR : TONER	The toner cartridge is not installed correctly.	Install the toner cartridge correctly.
	The recommended toner cartridge is not being used.	If you are using a toner cartridge other than the one we recommend, the equipment may not be able to detect whether it is installed or not. 📖 P.4 “Recommended toner cartridges”

Message	Meaning	Countermeasure
TONER EMPTY	The toner in the toner cartridge has run out.	Replace the toner cartridge with a new one. 📖 P.201 “Replacing Toner Cartridge”
MEMORY IS FULL PRESS ANY KEY	The built-in memory of the equipment has become full.	Press any button on the control panel to delete the scanned data.
CLEAR PAPER OUTPUT TRAY PRESS [START] KEY	Approx. 100 maximum sheets of paper have continuously exited and the equipment stops copying to prevent the copied paper from overflowing from the tray.	Remove the paper from the receiving tray, and then press [START] to resume copying. Press [CLEAR/STOP] to end the copy. When “MEMORY CLEAR?” appears on the LCD screen, select “YES”, and then press [START].
SET xxx	The paper size setting is incorrect.	Make sure the loaded paper size/type and setting on the control panel.
PLEASE WAIT ADMINISTERED BY PC	TopAccess has been closed by clicking [X] (Close) on the browser window instead of [Logout] by a user who logged in as an administrator (Admin).	Turn the equipment power OFF and back ON, or wait until the time set with TopAccess for [Web General Setting] – [Session Timer] passes (default: 10 minutes).
ERROR:PRINTER	An error has occurred inside the equipment.	Contact your service representative.
E-MAIL ERROR xxxx	Scan to E-Mail has failed.	Press any button on the control panel to clear the error. Confirm that the SMTP/POP3 settings and other network settings are specified correctly. For details, refer to the <b>TopAccess Guide</b> .
TO FILE ERROR xxxx	Scan to File has failed.	Press any button on the control panel to clear the error. Confirm that the Scan to File settings are specified correctly. For details, refer to the <b>TopAccess Guide</b> .
TO USB ERROR xxxx	Scan to USB has failed.	Press any button on the control panel to clear the error.  <b>Tip</b> Use a USB storage device that meets the following requirements. If a USB storage device does not work even though it meets the requirements, use one by another manufacturer. <ul style="list-style-type: none"> <li>• FAT16 or FAT32 format</li> <li>• Single partition</li> <li>• Storage space enough to save scanned data</li> </ul>
TO MOBILE ERROR xxxx	Scan to Mobile has failed.	Press any button on the control panel to clear the error. Confirm that there is an enough storage space in a mobile device.
PRESS [OK]. SELECT ANOTHER FOLDER	The number of files in the storing folder has exceeded its upper limit.	Decrease the number of files by deleting the unnecessary ones in the storing folder. Alternatively, select another folder to be used for storing.
FAX:ERROR	The paper in the drawer has run out or a communication error has occurred during fax transmission/reception.	Press [FAX] to confirm the error status. By referring to the error message displayed on the fax screen, follow its instructions in countermeasure.
CHECK Wi-Fi	The wireless LAN setting is improper.	When the Ethernet function and AP Mode are used simultaneously, you must set a different network segment in [IP ADDRESS] and [SUBNET MASK].

---

<b>Message</b>	<b>Meaning</b>	<b>Countermeasure</b>
CANNOT PRINT THIS DOCUMENT	An invalid file for USB PRINT is used.	Print a target file from a client computer.



## Paper Misfeed

### ■ Find the position of paper misfeeds

When a paper misfeed occurs in the equipment, the operation stops, the alert lamp blinks on the control panel, and a message appears on the LCD screen to indicate the positions where the paper is misfed.

Check the message, remove any misfed paper, and then press [START] to resume copying.

📖 P.171 “User Functions Menu List”

#### Tip

When a paper misfeed occurs in the equipment, the instruction to remove the misfed paper appears on the LCD screen. Press  $\triangle$  and  $\nabla$  to scroll up and down to read the instruction.

### ■ When paper misfeeds occur frequently

When paper misfeeds occur frequently, they may be due to one of the causes listed below:

- Unacceptable paper is used.  
📖 P.22 “Paper types not acceptable”
- The sizes of paper loaded in the drawer or on the bypass tray are not registered into the equipment properly.  
📖 P.32 “Preparation 3 - Registering Paper Size and Type”
- More misfed paper is still remaining after the release of a paper misfeed.
- The side guides are aligned too tight or too loose to the paper.
- The height of the stacked paper is exceeding the indicators in the drawer.

### ■ When removing misfed paper

Observe the following precautions when you remove misfed paper:

#### **Do not tear misfed paper.**

Remove misfed paper carefully with both hands. Do not pull the paper forcefully, otherwise the paper could tear and cause a misfed paper. Make sure there are no torn pieces of paper left in the equipment.

#### **⚠ CAUTION**

#### **Do not touch the fuser unit or the metal part around the unit.**

When you remove misfed paper within the fuser unit, do not touch the fuser unit or the metal part around the unit. If you touch the inside of the equipment, this could cause burns or any injury to your hands.

#### **Do not touch the photoconductive drum.**

When you remove the misfed paper within the transfer unit or the fuser unit, be careful not to touch the photoconductive drum. This could stain the copy images.

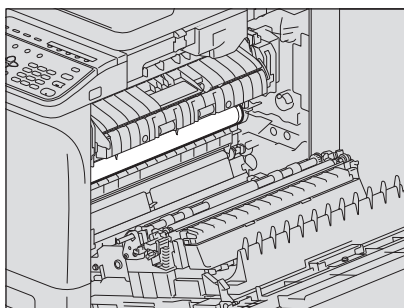

---

## ■ Paper misfeeds on the Reversing Automatic Document Feeder (RADF)

- 1 Open the upper cover.

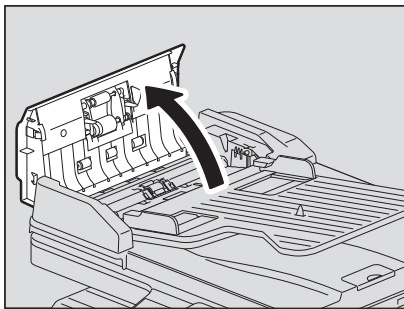

- 2 Open the transport guide and remove the original.

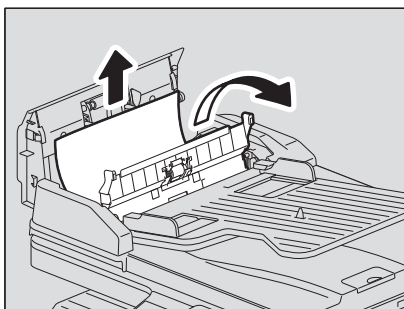

- 3 Open the Reversing Automatic Document Feeder.

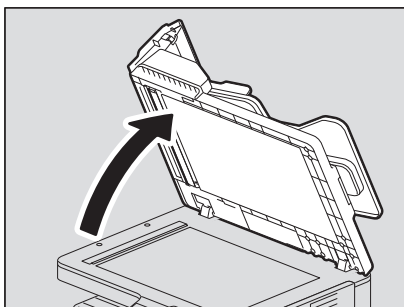

- 4 Turn the dial to remove the misfed original.

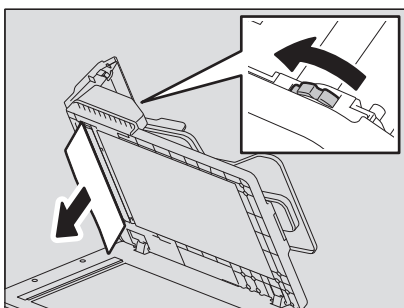

**5** Close the Reversing Automatic Document Feeder.

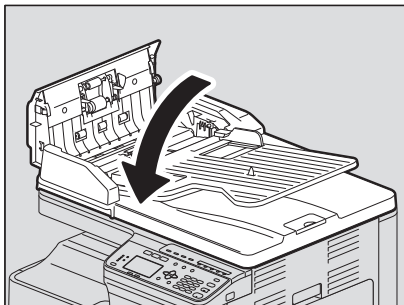

**6** Raise the feeder tray.

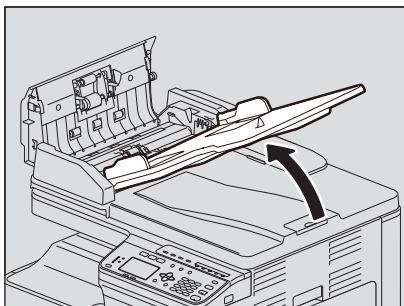

**7** Turn the dial to remove the misfed original.

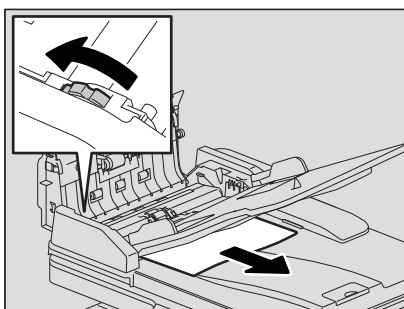

**8** Lower the feeder tray.

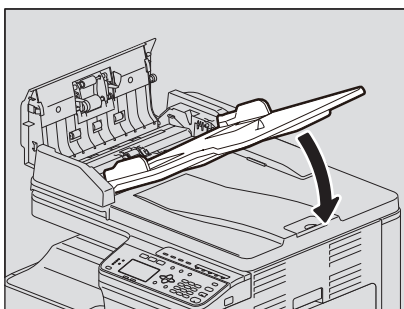

**9** Close the upper cover.

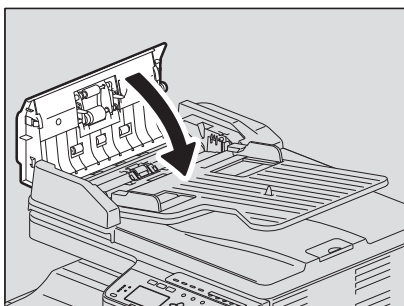

## ■ Paper misfeeds on the bypass tray

- 1 Pull the paper holding lever out, and then pull out the misfed paper on the bypass tray.

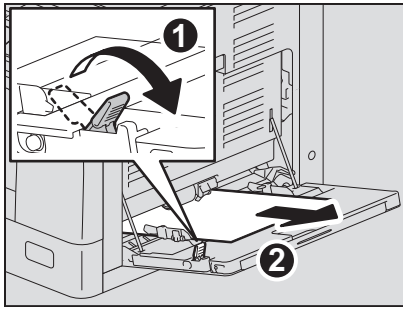

- 2 Check beneath the transport guide inside of the side cover.

Check if any paper is misfed under the transport guide behind the transfer unit.

📖 P.196 “Paper misfeeds inside of the side cover”

## ■ Paper misfeeds inside of the side cover

### ⚠ CAUTION

- **Be careful not to catch your fingers between the equipment and the side cover.**  
This could injure you.
- **Do not touch the fuser unit or the metal part around the unit.**  
If you touch the inside of the equipment, this could cause burns or any injury to your hands.

- 1 Open the side cover.

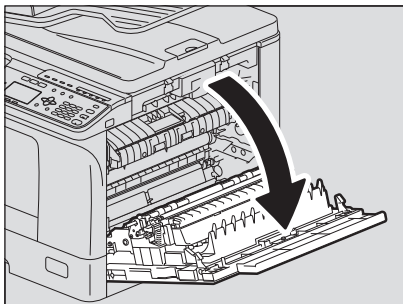

- 2 Remove the misfed paper behind transfer unit.

### Note

Be sure not to touch the photoconductive drum when removing the misfed paper.

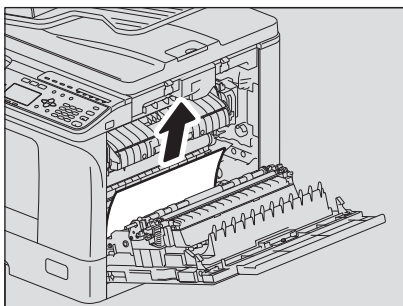

**Note**

If you cannot see the misfed paper, turn the dial (green) of the transfer unit to remove the misfed paper.

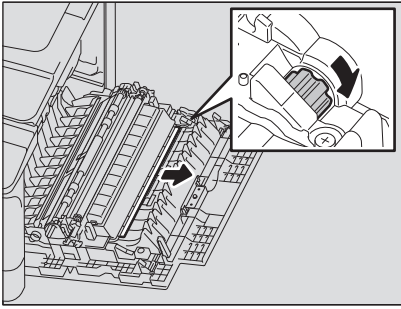

- 3** If you cannot see the misfed paper or it is difficult to remove, open the drawer in which you have loaded paper and remove it.

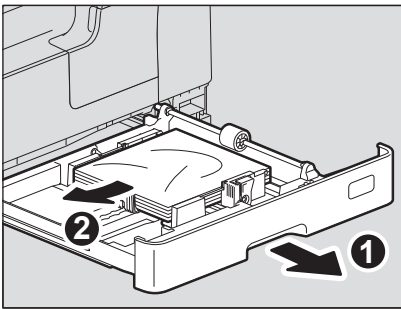
**Note**

Be sure that the height of the stacked paper does not exceed the line indicated inside of the side guides.

- 4** Close the drawer.
- 5** Lay down the transfer unit, and then press down the two fuser pressure release levers (green) until they come to a stop.

**Note**

Press down the levers fully until they stop.

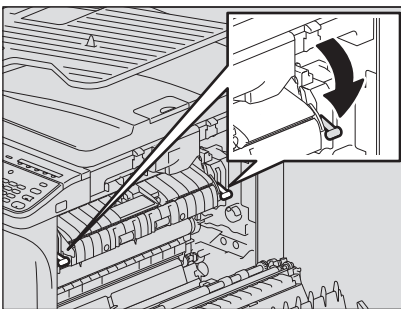

- 6** Raise the transport guide.

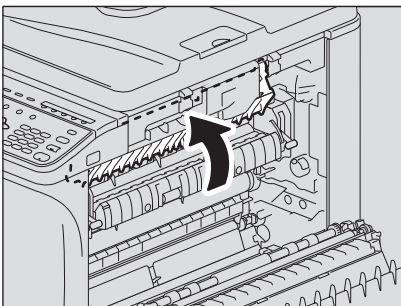

## 7 Release the misfed paper within the fuser unit.

Pull the misfed paper up or down as shown below depending on its position.

### Note

Be sure not to touch the photoconductive drum when releasing the misfed paper.

Pulling it up

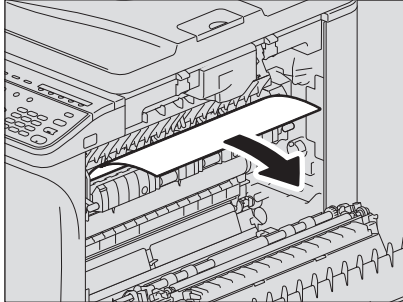

Pulling it down

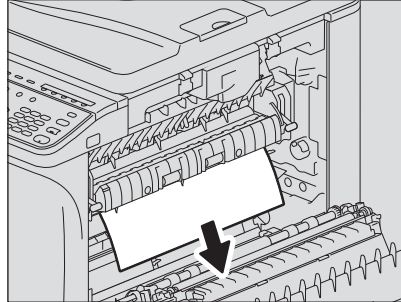

## 8 Return the transport guide and transfer unit to their original positions, and then close the side cover.

### ■ Paper misfeeds within the Paper Feed Unit

#### 1 Open the side cover and check if any paper is misfed behind the transfer unit.

 P.196 "Paper misfeeds inside of the side cover"

#### 2 Open the paper feed cover of the unit.

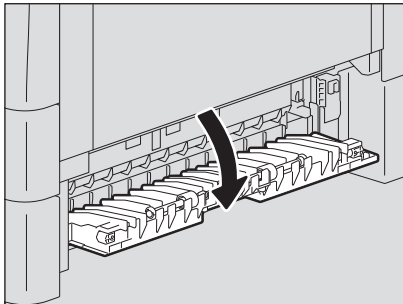

#### 3 Release the misfed paper.

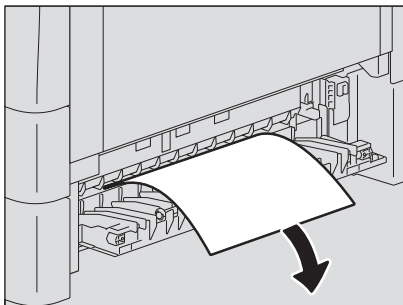

- 4** If it is difficult to find or remove the misfed paper, open the drawer of the Paper Feed Unit.

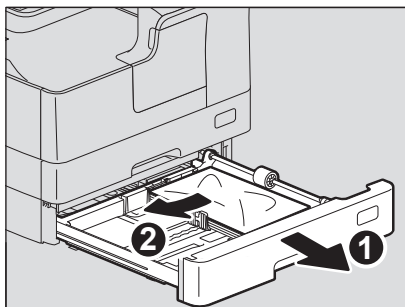

- 5** Check that the guide width is correct, there is no folded/curled paper or overloading, and then close the drawer.

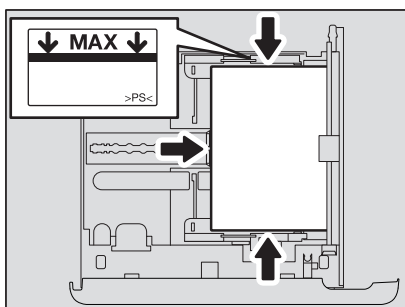

**Note**

- Be sure that the height of the stacked paper does not exceed the line indicated inside of the side guides.
- Do not allow any gap between the paper and the end guide in the drawer.

- 6** Close the paper feed cover of the unit and the side cover.

**■ Paper misfeeds within the Paper Feed Pedestal**

- 1** Open the side cover and confirm that no misfed paper has remained in the transfer unit.

P.196 "Paper misfeeds inside of the side cover"

- 2** Open the paper feed cover of the Paper Feed Pedestal.

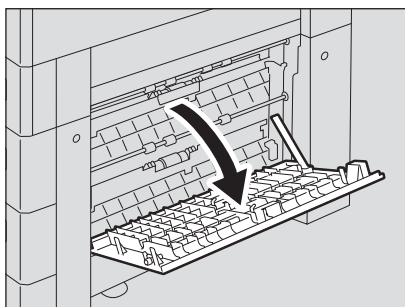

- 3** Release the misfed paper.

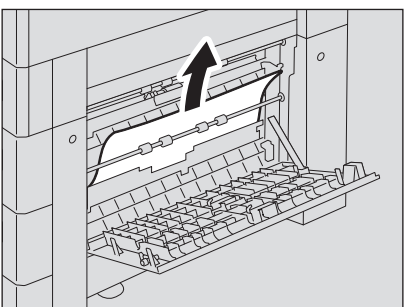

---

**4** Close the paper feed cover of the Paper Feed Pedestal.



# Replacing Toner Cartridge

## ■ When a message for replacement appears

When the toner cartridge runs out of toner, the message appears on the LCD screen and the alert lamp blinks on the control panel.

**⚠ WARNING**

**Never attempt to incinerate toner cartridges.**

Dispose of used toner cartridges in accordance with local regulations.

**Do not touch the terminal of the toner cartridge.**

This may cause the equipment not to recognize the toner cartridge or may damage the terminal.

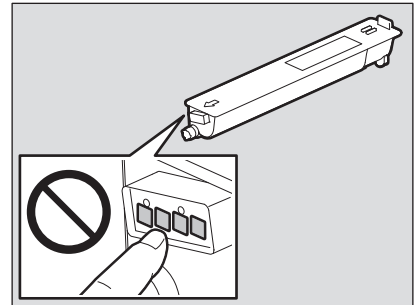

**Note**

- Before inserting a new toner cartridge, check that the product name is “T-2323”.
- Do not touch the parts on the circuit board mounted on the toner cartridge because they may be damaged.

**1 Open the front cover.**

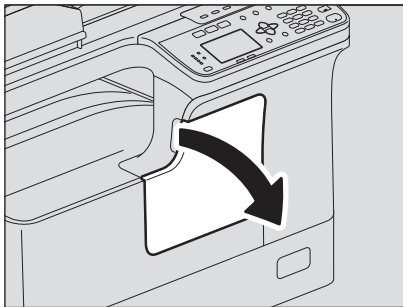

**2 While holding down the green lever, pull out the toner cartridge.**

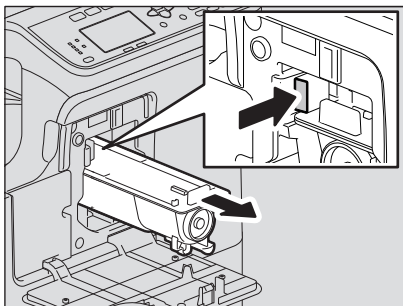

**⚠ WARNING**

**Never attempt to incinerate toner cartridges.**

Dispose of used toner cartridges and waste toner boxes in accordance with local regulations.

**3 Hold the new toner cartridge with its seal side up.**

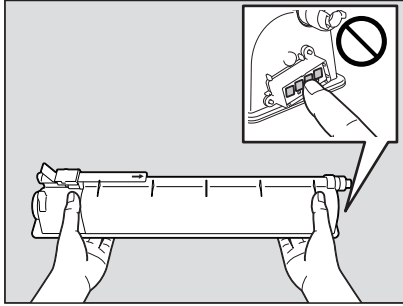

**Note**

Do not touch the metal contact on a circuit board.

**4 Shake the new toner cartridge strongly with its seal side up to loosen the toner inside.**

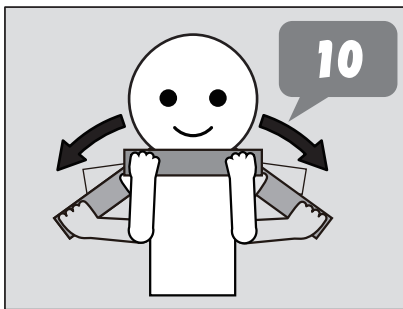

**5 Pull out the seal in the direction of the arrow.**

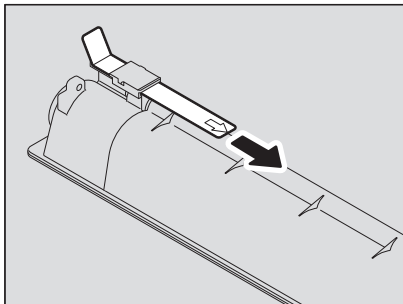

**6 Insert the toner cartridge along the rail.**

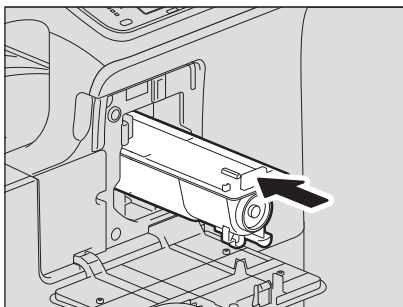

**Note**

Insert the toner cartridge until you hear a click sound.

## 7 Clean the charger.

Hold the cleaning knob of the charger and pull it out toward you carefully until it stops. Then reinsert it in its original position carefully. Repeat this procedure two to three times.

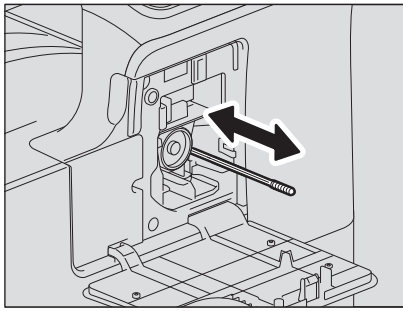

### Note

Check if the cleaning knob is fully inserted after cleaning.

## 8 Close the front cover.

## Before Calling Service Technician

When you encounter troubles, find the symptom listed below and follow the instructions in the Countermeasure.

### ■ General operation

Phenomenon	Usual cause	Countermeasure
The equipment does not work at all.	The power is not turned ON.	Turn ON the power of the equipment.
	The power cable is not plugged in securely.	Plug in the power cable securely.
The button does not respond to my operation.	It has been a short time since the power was turned ON.	Wait for the completion of warm-up and then try again.
The LCD screen is too light/dark.	The contrast of the LCD screen is not adjusted properly.	Adjust the contrast. 📖 P.171 “User Functions Menu List”
A message is displayed on the LCD screen.	The equipment has detected an error status.	See the meaning of the message referring to the listing below. 📖 P.190 “When This Message Appears”
“SAVING ENERGY” appears on the LCD screen.	The equipment is in the low power mode.	Press any button on the control panel to cancel this mode. Copying is enabled in the low power mode. 📖 P.19 “Saving energy when not in use - Energy saving mode -”
The LCD screen is dim.	The equipment is in the sleep mode.	Press any button on the control panel to cancel this mode. 📖 P.19 “Saving energy when not in use - Energy saving mode -”
Copy functions cannot be set.	Some copy functions that cannot be set simultaneously with others have been set.	Some copy functions cannot be set together with others. 📖 P.217 “Copying Function Combination Matrix”
The equipment is not recognized when it is connected to a PC using a USB cable.	The cable is not support the USB2.0 Hi-Speed.	Use a USB2.0 Hi-Speed certified cable.
	The equipment is connected via a USB hub.	Connect the equipment with a PC directly by a USB cable.

### ■ Toner-related items

Phenomenon	Usual cause	Countermeasure
“TONER IS LOW” appears on the LCD screen.	Toner is running out.	There is still a little toner remaining in the toner cartridge. Do not replace the toner cartridge until “TONER EMPTY” appears on the LCD screen.
“TONER EMPTY” appears on the LCD screen.	Toner has run out.	Replace the toner cartridge with a new one.
“ERROR : TONER” appears on the LCD screen.	The toner cartridge is not installed, or it is installed incorrectly.	Install the toner cartridge correctly.
	The recommended toner cartridge is not being used.	If you are using a toner cartridge other than the one we recommend, the equipment may not be able to detect whether it is installed or not. 📖 P.4 “Recommended toner cartridges”



Phenomenon	Usual cause	Countermeasure
"TONER IS LOW" does not appear on the LCD screen, although toner is nearly empty.	The recommended toner cartridge is not being used.	If you are using a toner cartridge other than the one we recommend, the equipment may not be able to detect whether it is installed or not. 📖 P.4 "Recommended toner cartridges"
The equipment does not become ready after the toner cartridge is inserted.	The toner cartridge inserted is not usable for this equipment.	Check that the product name is "T-2323".

## ■ Original/Paper-related items

Phenomenon	Usual cause	Countermeasure
Paper misfeeds.	The paper is unsuited for the equipment.	Check if the paper is acceptable. 📖 P.22 "Paper types not acceptable"
	The paper size is not registered properly in the equipment.	Register the paper size properly. 📖 P.32 "Preparation 3 - Registering Paper Size and Type"
	Misfed paper is located in a place you cannot see easily.	See the message on the LCD screen to recheck the position where the paper misfeed has occurred. 📖 P.193 "Paper Misfeed"
	There is no gap between the side guides and paper in the drawer, or the gap is too wide.	Adjust the gap between the side guides and the paper properly. 📖 P.23 "Loading paper in the drawer/Paper Feed Unit"
Multiple feeding occurs.	Sheets of paper are clinging to each other.	Fan the paper well and place it again.

## ■ Image trouble

Phenomenon	Usual cause	Countermeasure
The copy image is light.	Toner has run out.	Replace the toner cartridge if the "TONER EMPTY" message appears on the LCD screen. 📖 P.201 "Replacing Toner Cartridge"
	The copy density is set lighter.	Make the density darker if you use the manual copy density mode.
	The image calibration is improper.	Perform auto calibration. 📖 P.172 "User functions menu items"
The copy image is dark.	The copy density is set darker.	Make the density lighter if you use the manual copy density mode.
	The image calibration is improper.	Perform auto calibration. 📖 P.172 "User functions menu items"

Phenomenon	Usual cause	Countermeasure
The copied image is stained.	The Platen Cover or the Reversing Automatic Document Feeder is not lowered fully.	Lower it fully to block outside light.
	The original glass or platen sheet is dirty.	Clean them. 📖 P.208 “Regular Cleaning”
	The copy density is set darker.	Make the density lighter if you use the manual copy density mode.
	Highly transparent originals such as overhead transparencies or tracing paper are used.	Place a blank plain sheet of paper, the same size as the original or larger, over the original.
The copy image is fogged. 	There is a slight gap between the original glass and the original.	Lower the Platen Cover or the Reversing Automatic Document Feeder fully so that the original will contact with the original glass.
	The paper is damp.	Replace with dry paper.
	The copied text is blurred depending on the type (such as a map) of original.	Adjust the sharpness.
The copy image is partially missing.	The size or direction of the paper and the original, or the reproduction ratio is not set properly.	Use paper of the same size as the original or set the reproduction ratio suitable to the paper size.
	The margin for binding is too wide.	Adjust the image shift value again. 📖 P.57 “Shifting the pages to the right or left”
The copy image has black streaks in a horizontal direction. 	The charger is dirty.	Clean the charger. 📖 P.209 “Cleaning Charger”

## MAINTENANCE AND INSPECTION

Regular Cleaning .....	208
Cleaning Charger .....	209

## Regular Cleaning

---

We recommend you to clean the following items weekly, so that the originals can be scanned in unsoiled conditions.

### Note

- Be careful not to scratch the portions in cleaning.
- When cleaning the surface of the equipment, do not use such organic solvents as thinner or benzine. This could warp the shape of the surface or leave it discolored.
- When using a chemical cleaning pad to clean it, follow the instructions.

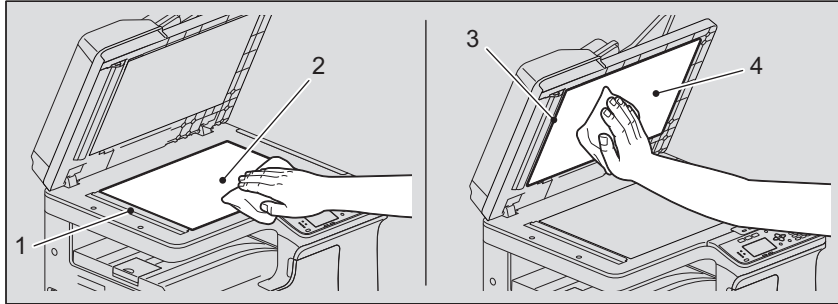

### 1. Scanning area (surface of the long rectangular glass) / 2. Original glass

Wipe it with a soft dry cloth. If there are still stains remaining, wipe it clean with a piece of soft cloth which has been moistened with water and then squeezed well.

Do not use liquids other than water (such as alcohol, organic solvents or neutral detergent).

### 3. Guide / 4. Platen sheet

Clean the surface as follows depending on the staining.

- Clean it with a soft cloth.
- Clean it with a soft cloth lightly moistened with water.
- Clean it with a soft cloth lightly moistened with alcohol, and then wipe it with a dry cloth.
- Clean it with a soft cloth lightly moistened with watered-down neutral detergent, wipe it with a wet cloth and then with a dry cloth.

### Note

You need to clean 1 (scanning area) and 3 (guide) only when using Reversing Automatic Document Feeder.



## Cleaning Charger

If the inside of the charger is dirty, staining may appear on the copied image. Clean the charger following the procedure below.

### 1 Open the front cover.

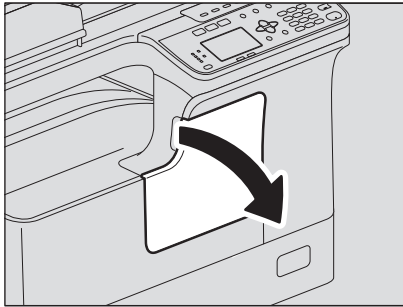

### 2 Clean the charger.

Hold the cleaning knob of the charger and pull it out toward you carefully until it stops. Then reinsert it in its original position carefully. Repeat this procedure two to three times.

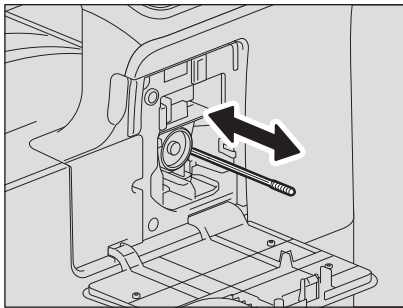

#### Note

Check if the cleaning knob is fully inserted after cleaning.

### 3 Close the front cover.



## APPENDIX

<b>e-STUDIO2329A/2829A Specifications .....</b>	<b>212</b>
Continuous copying speed .....	213
<b>Specifications of Options .....</b>	<b>214</b>
<b>Packing List .....</b>	<b>216</b>
<b>Copying Function Combination Matrix .....</b>	<b>217</b>
Combination matrix.....	217

## e-STUDIO2329A/2829A Specifications

Model name		DP-2329A/2829A
Type		Desktop type
Original glass		Fixed
Printing (copying) system		Indirect electrophotographic method
Developing system		2-component magnetic brush developing
Fusing method		Two halogen lamp
Photosensor type		OPC
Original scanning system		Flat surface scanning system (When the Reversing Automatic Document Feeder is installed: Fixed scanning system by feeding the original)
Original scanning sensor		Linear CMOS sensor
Scanning light source		LED
Resolution	Writing	2400 dpi x 600 dpi (Smoothing process)
	Scanning	600 dpi x 600 dpi
Acceptable originals		Sheets and books
Acceptable original size		Original glass: Max. A3 or LD Reversing Automatic Document Feeder: Max. A3 or LD
Acceptable paper size	Drawer	A3, A4, A4-R, A5-R, B4, B5, B5-R, FOLIO, LD, LG, LT, LT-R, ST-R, COMP, 13"LG, 8.5"SQ, 8K, 16K, 16K-R
	Bypass	A3, A4, A4-R, A5-R, B4, B5, B5-R, FOLIO, LD, LG, LT, LT-R, ST-R, COMP, 13"LG, 8.5"SQ, 8K, 16K, 16K-R, COM10, Monarch, DL
Acceptable paper weight	Drawer	64 - 80 g/m <sup>2</sup> (17 - 20 lb. Bond)
	Bypass	64 - 80 g/m <sup>2</sup> (17 - 20 lb. Bond) : for continuous feed 52 - 63 g/m <sup>2</sup> (14 lb. Bond - 16 lb. Bond), 81 - 216 g/m <sup>2</sup> (21 lb. Bond - 110 lb. Index/80 lb. Cover) : for single feed
Warm-up time		Approx. 15 seconds (when the Reversing Automatic Document Feeder is not installed), Approx. 24 seconds when GA-1350L/H is installed
First copy time (A4 or LT portrait)		A4: Approx. 6.4 seconds LT: Approx. 6.5 seconds
Continuous copy speed		 P.213 "Continuous copying speed"
Multiple copying		Up to 999 copies
Excluded image width	Copy	Leading edge: 3.0±2.0 mm (0.12"±0.08") Trailing edge: 2.0±2.0 mm (0.08"±0.08") Both edges: 2.0±2.0 mm (0.08"±0.08")
	Printer	Leading edge: 5.0±3.0 mm (0.20"±0.12") Trailing edge: 5.0±3.0 mm (0.20"±0.12") Both edges: 5.0±3.0 mm (0.20"±0.12")
Reproduction ratio	Actual size	100±0.5%
	Zoom	25 - 400% (in 1% increments)
Storage capacity		Max. 150 sheets or until the memory is full (Toshiba's own chart)
Paper supply	Drawer	250 sheets (80 g/m <sup>2</sup> , 20 lb. Bond)
	Bypass	100 sheets (80 g/m <sup>2</sup> , 20 lb. Bond)
Loading capacity for the receiving tray		Approx. 100 sheets (80 g/m <sup>2</sup> , 20 lb. Bond)

Toner density adjustment	Magnetic auto-toner system
Exposure control	Automatic plus manual selection from 9 exposure steps
Memory	512 MB (1 GB when GA-1350L/H is installed)
USB interface	USB2.0 (Hi-Speed)
Environment (for normal use)	Temperature: 10 ° - 30 °C, Humidity: 20 - 85% (No condensation)
Power requirements and power consumption (including optional equipments)	AC 220 - 240 V±10%, 8 A (50 - 60 Hz): 1.5 kW or less AC 120 V±10%, 12 A (60 Hz): 1.5 kW or less
Dimensions (equipment only)	575 mm (22.6") (W) x 565 mm (22.2") (D) x 402 mm (15.8") (H)
Weight (including equipment and drum)	Approx. 24.4 kg (53.8 lb.)
Space occupied (equipment only)	943 mm (37.1") (W) x 565 mm (22.2") (D)

- These specifications vary depending on the copying conditions and the environment.
- Specifications and appearance are subject to change without notice in the interest of product improvement.

## ■ Continuous copying speed

The values below are measured when originals are set on the original glass, 100% and nonsort multiple copies are made.

sheets/min.

Paper size	Paper source	e-STUDIO2329A	e-STUDIO2829A
A4, A5-R, B5, LT, ST-R*1	Drawer	23	28
	Bypass tray	23	28
A4-R, B5-R, LT-R	Drawer	19	19
	Bypass tray	19	19
B4, FOLIO, LG, COMP, 13"LG	Drawer	16	16
	Bypass tray	16	16
A3, LD	Drawer	14	14
	Bypass tray	14	14

\*1 ST-R can be loaded only on the bypass tray.

- Toshiba-recommended paper is used for the values of the specifications above.
- The bypass copying speed is as listed above when specifying the paper size.
- This specification varies depending on the copying conditions and the environment.

## Specifications of Options

### Reversing Automatic Document Feeder

Model name	MR-3032
Copy sides	1-side, duplex
Number of originals (A4)	50 originals (80 g/m <sup>2</sup> , 20 lb. Bond) or 9.5 mm or less in height (more than 80 g/m <sup>2</sup> , 20 lb. Bond)
Feeding speed	37 - 111 mm/s
Acceptable originals	A3, A4, A4-R, A5-R, B4, B5, B5-R, LD, LG, LT, LT-R, ST-R, COMP, 8K, 16K, 16K-R
Paper weight	50 - 104 g/m <sup>2</sup> , 13 - 27 lb. Bond
Power source	Power supplied from the equipment
Dimensions	560 mm (22.05") (W) x 670 mm (26.38") (D) x 195 mm (7.68") (H)
Weight	Approx. 4.5 kg (9.9 lb)
Power consumption	40 W max.

### Paper Feed Unit

Model name	MY-1043
Acceptable paper size	A3, A4, A4-R, A5-R, B4, B5, B5-R, FOLIO, LD, LG, LT, LT-R, ST-R, COMP, 13"LG, 8.5"SQ, 8K, 16K, 16K-R
Paper weight	64 - 80 g/m <sup>2</sup> , 17 - 20 lb. Bond
Maximum capacity	250 sheets (80 g/m <sup>2</sup> , 20 lb. Bond)
Dimensions	575 mm (22.64") (W) x 565 mm (22.24") (D) x 117 mm (4.61") (H)
Weight	Approx. 5.5 kg (12.1 lb)

### Paper Feed Pedestal

Model name	KD-1039
Acceptable paper size	A3, A4, A4-R, A5-R, B4, B5, B5-R, FOLIO, LD, LG, LT, LT-R, ST-R, COMP, 8K, 16K, 16K-R
Paper weight	64 - 80 g/m <sup>2</sup> , 17 - 20 lb. Bond
Maximum capacity	550 sheets (80 g/m <sup>2</sup> , 20 lb. Bond)
Dimensions	575 mm (22.64") (W) x 575 mm (22.64") (D) x 406 mm (15.98") (H)
Weight	Approx. 22.0 kg (48.5 lb)

### Drawer Module

Model name	MY-1044
Acceptable paper size	A3, A4, A4-R, A5-R, B4, B5, B5-R, FOLIO, LD, LG, LT, LT-R, ST-R, COMP, 8K, 16K, 16K-R
Paper weight	64 - 80 g/m <sup>2</sup> , 17 - 20 lb. Bond
Maximum capacity	550 sheets (80 g/m <sup>2</sup> , 20 lb. Bond)
Dimensions	573 mm (22.6") (W) x 557 mm (21.93") (D) x 107 mm (4.21") (H)
Weight	Approx. 3.0 kg (6.6 lb)

**Wireless LAN Module**

Model name	GN-1160
Transmission format	IEEE 802.11b/g/n standard Direct Sequence Spread Spectrum (DSSS) Orthogonal Frequency Division Multiplexing (OFDM)
Data transmission speed	IEEE 802.11b: 11, 5.5, 2, 1 Mbps IEEE 802.11g: 54, 48, 36, 24, 18, 12, 9, 6 Mbps IEEE 802.11n: MCS0-15 (HT20/40)
Frequency band	2.4 GHz (2412 to 2462 MHz)
Transmitter power	Max. 20 dBm
Access method	CSMA/CA
Wireless category	Low-power data transmission system
Security	Static WEP Key Length: 40 bit, 104 bit WPA2: PSK(AES(CCMP)) WPA2/WPA mixed: PSK(AES(CCMP))+TKIP
Operation mode	Infrastructure Mode, AP Mode, WPS2.0 PBC or PIN method
Wireless ON/OFF	Available
Wired LAN/Wireless LAN simultaneous operation	Not Available

**FAX Unit**

Model name	GD-1380
------------	---------

For detail specifications, see the following manual.

 **Fax Guide**

**PostScript Kit**

Model name	GA-1350L/H
------------	------------

Toshiba-recommended paper is used for the values above. Specifications and appearance are subject to change without notice in the interest of product improvement.

## Packing List

---

Packing list	Safety Information
	Quick Guide
	Power cable
	DVD







# INDEX

---

## Numerics

2IN1/4IN1..... 51, 164, 173, 178  
2-SIDED..... 164, 173, 179  
2-Sided Printing..... 84, 97  
2-SIDED SCAN..... 173, 178

## A

A4-R/LG SWITCH..... 173, 178, 179  
AC-IN terminal..... 11  
ADDRESS BOOK..... 174, 180, 182  
[ADDRESS BOOK] button..... 14  
ADDRESS MODE..... 176  
ADF/Platen..... 122  
Alert lamp..... 16  
All pages from..... 111  
AMS (Automatic Magnification Selection)..... 44  
Angle..... 90, 101  
ANNOTATION..... 164  
AP MODE..... 181  
Application window..... 125  
APS (Automatic Paper Selection)..... 42  
AUTO 2-SIDED MODE..... 173, 177  
AUTO CALIBRATION..... 172, 177  
AUTO CLEAR..... 172, 175  
AUTO DETECT..... 172, 177  
AUTO JOURNAL..... 173  
AUTO LEVEL..... 173, 177  
AUTO POWER SAVE..... 172, 175  
Automatic Magnification Selection (AMS)..... 44  
Automatic Paper Selection (APS)..... 42

## B

BACKGROUND..... 173, 178  
[Basic] tab..... 80, 81, 95  
BLACK SETTING..... 173, 179  
Booklet..... 84  
Booklet Details..... 86  
Border..... 109  
Bypass tray..... 12, 20

## C

[CANCEL] button..... 16  
Caption..... 89, 100  
CC (ADDRESS)..... 165  
Center Watermark..... 89  
CHANGE LANGUAGE..... 172, 174  
CHANNEL..... 181  
[CLEAR/STOP] button..... 15  
CLOCK..... 172, 174  
Collate pages..... 110  
COLOR MODE..... 165, 167, 173, 178  
COMPLETE..... 172, 176  
COMPRESS..... 165, 167, 173, 178  
Configuration of options..... 13  
Configuration Settings..... 68  
[Configuration] tab..... 80, 93  
CONNECTION INFO..... 181  
Considerations..... 73, 104  
CONTACT NAME..... 177  
CONTACT TEL NUMBER..... 177  
CONTINUE SCAN..... 164, 165, 167, 173, 178, 179

Continuous copying speed..... 213  
Control panel..... 10, 14  
Copies..... 108  
Copies & Pages..... 108  
COPY..... 173, 177  
[COPY] button..... 15  
Copy Handling..... 83, 96, 97  
Copy quantity..... 17  
COUNTER..... 174, 180, 182  
Cover Page..... 112  
Cover Page Type..... 112  
Custom Page Sizes..... 107  
Custom Paper Size..... 91  
CUSTOMER E-MAIL..... 176  
CUSTOMER INFO..... 172, 176  
CUSTOMER NAME..... 176  
CUSTOMER NUMBER..... 177  
CUSTOMER TEL NO..... 176

## D

[DATA] lamp..... 16  
DATE FORMAT..... 172, 174  
DATE/TIME..... 172, 174  
DEFAULT GATEWAY..... 176  
Default Menu Setting..... 90  
DEFAULT SETTING..... 172  
DEPARTMENT..... 174, 180  
DEPARTMENT CODE..... 172, 175  
Department Code..... 68, 91, 113  
Department Code(DC) - Digit 1..... 114  
Department Code(DC) - Digit 2..... 114  
Department Code(DC) - Digit 3..... 114  
Department Code(DC) - Digit 4..... 114  
Department Code(DC) - Digit 5..... 114  
Destination Paper Size..... 111  
DESTINATION SETUP..... 172, 177  
Digital keys..... 15  
Direction of Print..... 84, 99  
Distinguish Thin Lines..... 87, 113  
Do not Print Blank Pages..... 91, 113  
Draw as Outline..... 90, 101  
Draw Borders Around Pages..... 84, 99  
DRAWER..... 164, 174, 182  
Drawer..... 10, 20  
[DRAWER] button/lamps..... 16  
Drawer Module..... 11, 20  
DRAWER SET..... 172, 175  
Drawer Setting..... 93  
Drawers..... 93  
DUAL PAGE..... 164

## E

Easy Set..... 124  
EDGE ERASE..... 164  
Edit window..... 131  
Editor Options..... 136  
[Effect] tab..... 80, 88, 99  
E-MAIL..... 165, 174, 177, 182  
E-MAIL ADDRESS..... 165  
E-MAIL ADDRESS1..... 176  
E-MAIL ADDRESS2..... 176

E-MAIL ADDRESS3 ..... 176  
 E-MAIL SETTINGS ..... 172, 176  
 Enable SNMP Communication ..... 93  
 [ENERGY SAVER] button..... 15  
 [Enhanced Settings] tab ..... 122  
 Enlarging copy..... 44  
 Envelope..... 20, 29  
 e-STUDIO Scan Editor ..... 125  
 ETHERNET ..... 172, 176  
 EXPOSURE ..... 38, 164, 165, 167, 173, 177, 179  
 Exposure..... 17  
 [EXPOSURE] button ..... 38  
 EXPOSURE LEVEL ..... 173, 177  
 Exposure/Contrast..... 122

**F**

FAX ..... 173  
 [FAX] button ..... 15  
 FAX NUMBER..... 177  
 FILE ..... 165  
 FILE FORMAT ..... 165, 166, 167  
 FILE NAME..... 165, 166, 167  
 File window ..... 130  
 FINISHING..... 164  
 [Finishing] tab ..... 80, 83, 96  
 First page from ..... 111  
 Flip horizontally ..... 110  
 Font Name ..... 89, 101  
 Font Size ..... 89, 101  
 Format For..... 106  
 Front cover ..... 10  
 FULL COLOR SETTING..... 173, 179  
 FUNCTION ..... 174, 180  
 [FUNCTION CLEAR] button ..... 15

**G**

GENERAL..... 172, 174  
 General ..... 113  
 GRAY SETTING ..... 173, 179  
 GROUP DIAL..... 174, 182  
 GROUP NUMBER ..... 165, 174, 182

**H**

Halftone..... 87, 115  
 Help..... 80  
 How to print ..... 73  
 HTTP ..... 172, 176  
 HTTP SERVER ..... 176

**I**

ID CARD ..... 38, 164  
 [ID CARD] button ..... 38  
 IMAGE DIRECTION ..... 164  
 [Image Quality] tab ..... 80, 87  
 IMAGE SHIFT ..... 164  
 INFORMATION ..... 174, 182  
 INFRASTRUCTURE..... 181  
 INITIAL SETUP ..... 173  
 Initial values ..... 76  
 INPUT ADDRESS ..... 165  
 IP ADDRESS ..... 176, 181

**J**

Job Status..... 185  
 [JOB STATUS] button..... 15  
 JPEG ..... 166, 167

**L**

Layout ..... 109  
 Layout Direction ..... 109  
 LCD CONTRAST ..... 172, 175  
 LCD screen ..... 16  
 Limitations..... 73, 104  
 LINE ..... 11  
 LIST ..... 174, 180  
 Long Edge ..... 84  
 Low power mode..... 19

**M**

Main screen (Copy) ..... 17  
 Manual ..... 93  
 MANUAL LEVEL ..... 173, 177  
 Manual Scale..... 82, 95  
 Margin  
   Center ..... 87  
   Outer..... 87  
   Units..... 87  
 MAXIMUM COPIES..... 173, 177  
 Maximum number of originals..... 34  
 Media Type..... 113  
 MEMORY TX ..... 173  
 Menu bar ..... 126  
 Menu Tabs..... 80  
 Message ..... 17, 190  
 MESSAGE SIZE ..... 165, 166  
 MIXED SIZE ORIGINAL..... 164, 165, 167  
 Model Selection ..... 93  
 [MONITOR] button..... 14  
 MULTI ..... 166, 167  
 MULTI TX ..... 173

**N**

NETWORK ..... 172, 176  
 Network interface connector..... 11  
 NIC STATUS..... 172, 176  
 Number of Copies..... 82  
 Number of pages per Sheet ..... 84, 99

**O**

OFF ..... 181  
 [OK] button ..... 16  
 OMIT BLANK PAGE ..... 164, 165, 167, 173, 178, 179  
 ON ..... 181  
 ONE TOUCH ..... 174, 182  
 One Touch button ..... 15  
 Option ..... 93  
 Orientation ..... 82, 106  
 ORIG. ORIENTATION ..... 173, 178  
 Original glass ..... 10  
 ORIGINAL MODE..... 38, 164, 165, 167, 173, 177, 179  
 Original Mode ..... 121  
 Original mode ..... 17, 41  
 [ORIGINAL MODE] button..... 38  
 Original Paper Size ..... 81, 95

Original scale.....	11
ORIGINAL SIZE.....	165, 167, 173, 178
Original Size .....	121
OTHER INFORMATION.....	172, 177
[Others] tab .....	80, 90
Output Document Layout.....	86, 98

## P

Packing list .....	216
Page Attributes.....	106
PAGE LAYOUT .....	173, 178
Page Order.....	111
Pages .....	109
Pages per Sheet.....	109
Pages to Print .....	110
Paper exit stopper.....	11
Paper Feed.....	111
Paper Feed Pedestal .....	11, 20
Paper Feed Unit.....	10, 20
Paper Handling .....	110
PAPER JAM RECOVERY.....	172, 175
Paper misfeed (bypass tray).....	196
Paper misfeed (RADF) .....	194
Paper misfeed (transfer unit) .....	196
PAPER SIZE .....	173, 179
Paper Size.....	106
Paper size .....	17, 20
Paper Source.....	82
Paper source .....	42
Paper Type .....	82
Paper types not acceptable.....	22
[PAUSE] button .....	14
PCL FONT.....	174, 180
PDF.....	166, 167
PHONE BOOK .....	174, 182
PHOTO CALIBRATION .....	172
Plain paper .....	20
Platen Cover .....	12
Platen sheet.....	10
POP UP.....	172, 175
Power switch.....	11, 18
Precautions	
for Reversing Automatic Document Feeder .....	34
Preferences.....	133
Pre-Scan .....	119
Preview window .....	80
PRIMARY PORT NUMBER.....	176
Print Cover Page.....	112
Print on First Page Only .....	89, 100
Print Options .....	76
Print Paper Size .....	81, 95
Printer Features .....	112
Printer Name .....	80
Printing .....	133
Printing Modes .....	113
Printing Modes DC.....	114
Profile .....	77, 80
PS FONT .....	174, 180

## Q

Quality .....	115
---------------	-----

## R

Receiving tray .....	11
Recommended paper.....	21
Reducing copy .....	44
Remaining from .....	111
REMOTE1.....	165
REMOTE1/2 .....	166
REMOTE2.....	165
REPORT SETTING .....	173
Reproduction ratio .....	17
RESOLUTION.....	165, 167, 173, 179
Resolution.....	88, 121
[RESOLUTION] button.....	14
Restore Defaults .....	90, 94
Resuming.....	37
Reverse page orientation.....	110
Reversing Automatic Document Feeder (RADF) .....	10
REVIEW LIST .....	165
RGB Adjustment .....	122
Rotate 180 Degrees .....	89
Rotated Sort .....	83, 97
ROTATION .....	165, 167, 173, 178
Rotation .....	122
RX PRINT .....	173

## S

Saturation .....	122
Scale.....	106
Scale to fit paper size .....	111
SCAN.....	173, 178
Scan.....	119
[SCAN] button.....	15
Scan options .....	120
Scan speed.....	159
Scanner .....	134
Scanning area .....	11
Scroll icon .....	17
SEARCH .....	165
Send .....	135
SEND NOW .....	176
SERIAL NUMBER .....	174, 182
SERVICE NOTIFY.....	172, 176
Sharp.....	122
SHARPNESS .....	173, 178
SHIP TO ADDRESS .....	177
SHIP TO NAME .....	177
Short Edge .....	84
Side cover .....	12
SINGLE .....	166, 167
SINGLE NUMBER.....	165, 174, 182
SINGLE/2-SIDED SCAN .....	165, 167
SLEEP MODE .....	172, 175
Sleep mode.....	19
Smoothing .....	87, 115
SNMP Settings .....	93
Solid .....	90, 101
SORT MODE PRIORITY .....	173, 177
Specifications .....	212, 214
Specifications of options .....	214
SPEED DIAL .....	174, 182
SSID/SECURITY .....	181

[START] button.....	15
Status Monitor.....	75
Sticker labels.....	20
Stopping.....	37
Storing paper.....	22
Style.....	89
SUBNET MASK.....	176, 181
SUPPLY NOTICE.....	172, 177

**T**

TCP/IP.....	172, 176
TEL.....	11
[TEMPLATE] button.....	15
TERMINAL ID.....	173
TEXT CALIBRATION.....	172
Thick paper.....	20
Thin paper.....	20
TIFF.....	166, 167
TIMERS.....	172, 175
TO (ADDRESS).....	165
Toner cartridge.....	10, 201
TONER EMPTY.....	201
TONER REMAIN.....	174, 182
Toner Save.....	90, 115
Tool bar.....	128
TOTAL COUNTER.....	174, 182
Tracing paper.....	20
Transparencies.....	20
Transparency.....	90, 101
TWAIN.....	118
Two Sided Printing.....	110
Two-Sided.....	109

**U**

Units.....	89
Update Automatically.....	93
Update Now.....	94
USB.....	165
USB port.....	12
USB PRINT.....	173, 179
USB terminal.....	11
USB WAKEUP.....	172, 175
Use Black for All Text.....	87
Use Custom Margin.....	85
[USER FUNCTIONS] button.....	15, 172

**V**

Version Information.....	93
--------------------------	----

**W**

WALKUP SCREEN.....	172, 175
Watermark.....	88, 89, 100
WEEKLY TIMER.....	172, 175
WIRELESS SETTING.....	174, 180
WPS.....	181

**X**

X Position.....	89
-----------------	----

**Y**

Y Position.....	89
-----------------	----

**Z**

ZOOM.....	164
-----------	-----



**MULTIFUNCTIONAL DIGITAL SYSTEMS**

**User's Guide**

**e-STUDIO2329A/2829A**

**Toshiba Tec Corporation**

1-11-1, OSAKI, SHINAGAWA-KU, TOKYO, 141-8562, JAPAN

© 2019, 2020 Toshiba Tec Corporation All rights reserved  
Patent; <http://www.toshibatec.com/en/patent/>

Ver01 F(-) 2020-08